



THOR-07/09/12AS-P US

Single-phase AC charger Quick installation guide

SHENZHEN GROWATT NEW ENERGY CO.,LTD.

4-13F, Building A, Sino-German(Europe) Industrial Park, Hangcheng Ave, Bao'an District, Shenzhen, China

T +86 755 2747 1900

E info@ginverter.com

W www.ginverter.com

Revised date:2022-09-13

Disclaimer

This user manual is copyrighted by Shenzhen Growatt New Energy Co., Ltd. (Hereinafter referred to as "Growatt"). No company or person may extract or copy part or all of this user manual without the written permission of Growatt. Content must not be transmitted in any form, including materials and publications.

All rights reserved.

Growatt has the final right to interpret this user manual. The information in this manual is subject to change without notice.

Thank you for using Growatt THOR EV chargers equipment!

THOR series intelligent single phase AC charger is a power supply device that uses professional and advanced technology to provide energy supply to electric vehicles, it also has friendly man-machine interface and versatile functions of control, billing, and communication. The charger can be connected to a back-office server to realize the functions of reservation and payment via Mobile phone APP. Diversified communication options, including wired Ethernet, WIFI, 4G is available for back-office server connection.

Menu

1. Product description	1
2. Packaging list	3
3. Installation and wiring	4
4. APP download, register, and login	8
4.1 APP download	8
4.2 Register	8
4.3 Sign in and log out	10
5. EV Charger Internet Configuration.....	10
5.1 WiFi Configuration.....	12
5.2 Network Cable Connection Configuration	14
5.3 4G Configuration	16
5.4 AP Mode Configuration	16
6. Operation instruction and LCD description	18
6.1 Charging mode and Operation.....	18
6.2 LCD interface introduction.....	20
7. EV Charger WorkModes	22
7.1 Fast Mode.....	22
7.2 PV Linkage Mode.....	24
7.3 Off-peak modes	29
7.4 Load balancing function	30
8. Other Settings	33
9. Record	37
10. Data	38
11. Configuration through internal web (Service Tool)	39
12. Troubleshooting	53
13. Specification	61
14. Annex	62

1. Product description

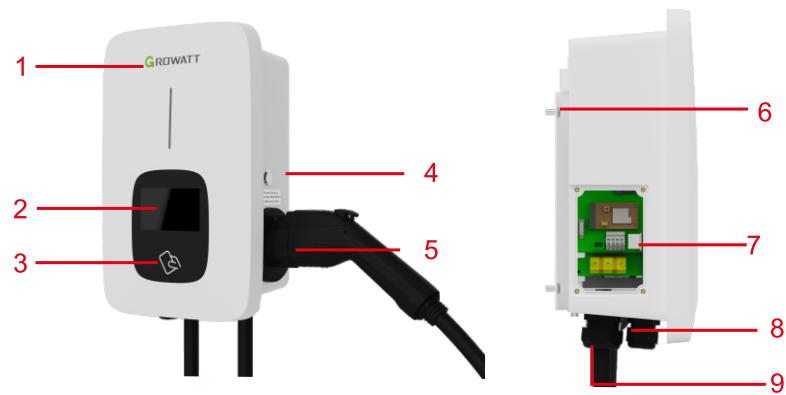

- 1.LOGO and status indicator
- 2.LCD display (For LCD charger version)
- 3.RFID ready (For RFID version)
- 4.Start or stop button
- 5.Plug holder
- 6.Mounting bracket
- 7.Side window and nameplate
- 8.Waterproof cable gland for AC input cables
- 9.Waterproof cable gland for communication wires

Wiring definition in the side window

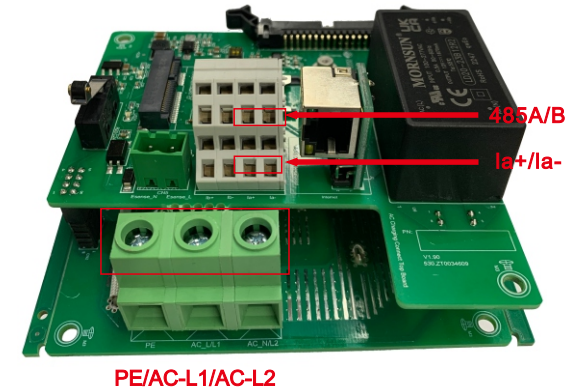

1. Terminal block for CT/meter wiring. The terminal definition is:
485A/485B is RS485 terminal for meter connection;
Ia+/Ia- is for CT connection
2. AC input terminals. Terminal definition is:
L1/L2/PE

2. Packaging list

No.	Name	Qty	Remark
1	Charger	1	
2	User manual	1	
3	Quality certificate	1	
4	Mounting bracket	1	
5	Cable hook	1	
6	ST6.3X40 Stainless steel hex-head self-drilling screws	7	
7	12X46 Plastic expansion plugs	7	
8	User card	1	RFID function will be equipped with user card

3. Installation and wiring

3.1 Mount on a wall

3.1.1 Open the packaging, you'll see a EV charger, a mounting bracket, a user manual and a bag of mounting accessories. There is also an RFID card if the EV charger point is RFID version. For cabled version, a cable hooker is also included inside.

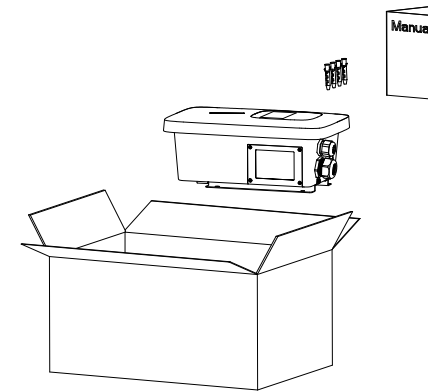

3.1.2 Remove the mounting bracket from the EV charger, use it as a template to mark the position of the drill holes. Drill the holes and hammer the expansion bolts in the accessories bag into the holes. Then fix the mounting bracket onto the wall.

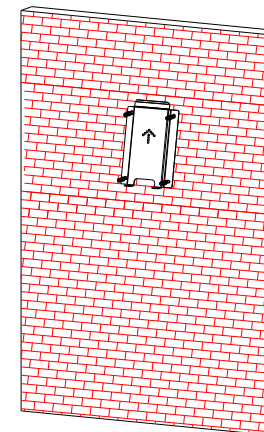

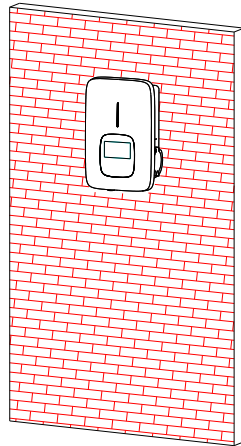

3.1.4 Crimp the below shown insulated ferrule or ring terminals on the end of the AC input wires. Connect the wires into the terminal block of the EV charger as below. Close the side window with the cover, then the wiring is done.

In Canada, a power supply that is intended to be fixed in place to a structure and is provided with a supply cord in accordance with 12.1.1.1 shall be marked with the following or equivalent: "THE SUITABILITY OF THE USE OF FLEXIBLE CORD IN ACCORDANCE WITH CE CODE, PART I, RULE 4-012, IS TO BE DETERMINED BY THE LOCAL INSPECTION AUTHORITY HAVING JURISDICTION"

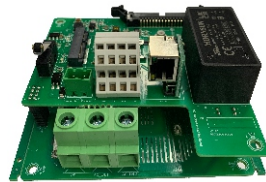
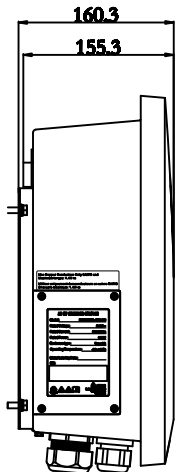

	Model	L 1	L 2	PE
Terminal	7K			
	9K			
	12K			
Wire	7K	≤AWG10	≤AWG10	≤AWG10
	9K	≤AWG9	≤AWG9	≤AWG9
	12K	≤AWG8	≤AWG8	≤AWG8

3.2 Mount on a pole

3.2.1 Open the packaging of the pole, take out the pole and mounting accessories.

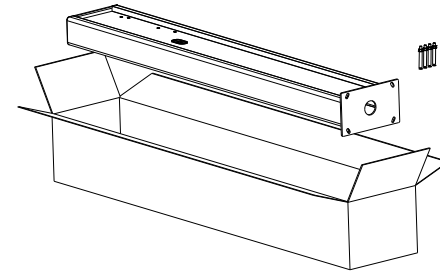

3.2.2 The pole must be installed on a hard surface, concrete surface is recommended, it can also be mounted on a solid ground. Drill holes according to the requirements marked on the illustration for fixing expansion bolts.

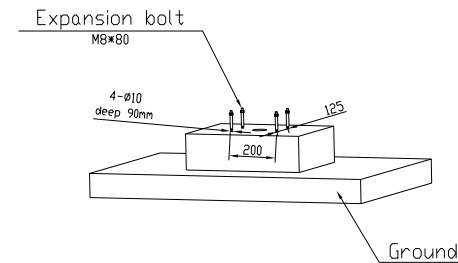

3.2.3 Fix the pole onto the holes with expansion bolts. The input cables shall go into the pole from the bottom middle area and come out of it from the area below the cable hooker.

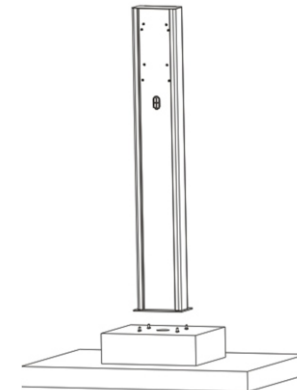

3.2.4 Fix the mounting bracket onto the pole.

3.2.5 Position the EV charger onto the bracket and secure it on the bracket with the 2 screws.

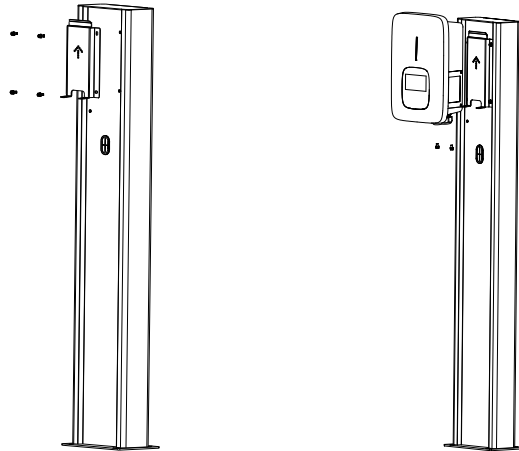

3.2.6 Crimp the below shown insulated ferrule or ring terminals on the end of the AC input wires. Connect the wires into the terminal block of the EV charger as below. Close the side window with the cover, then the wiring is done.

In Canada, a power supply that is intended to be fixed in place to a structure and is provided with a supply cord in accordance with 12.1.1.1 shall be marked with the following or equivalent: "THE SUITABILITY OF THE USE OF FLEXIBLE CORD IN ACCORDANCE WITH CE CODE, PART I, RULE 4-012, IS TO BE DETERMINED BY THE LOCAL INSPECTION AUTHORITY HAVING JURISDICTION"

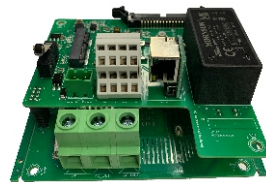
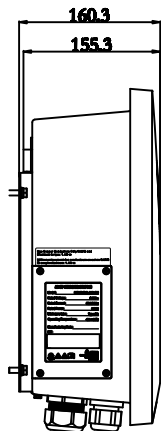

	Model	L1	L2	PE
Terminal	7K			
	9K			
	12K			
Wire	7K	≤AWG10	≤AWG10	≤AWG10
	9K	≤AWG9	≤AWG9	≤AWG9
	12K	≤AWG8	≤AWG8	≤AWG8

4. APP download, register, and login

4.1 APP download.



Users can scan the QR code (Android and IOS) with the WeChat, or go to the App Store and Google Play to search for ShinePhone or log in to our monitoring website server.growatt.com or server-cn.growatt.com to download.

4.2 Register

Before using ShinePhone APP the first time, the user must register an account in advance.

There are two steps when users register the account:

(1) Fill in the account registration information

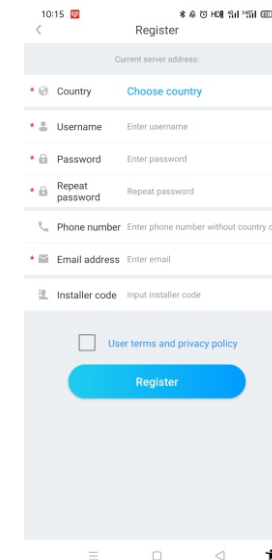

a) Fill in the account information. To fill in the account information, you need to select the account country (required), fill in the user name (required), password (required), confirm password (required), telephone (required in China, optional for other regions), email (optional in China, required for other regions), installer code(optional).

b) The user terms must be checked manually to agree before registering, all required fields must be filled in before registering.

(2) Add Plant

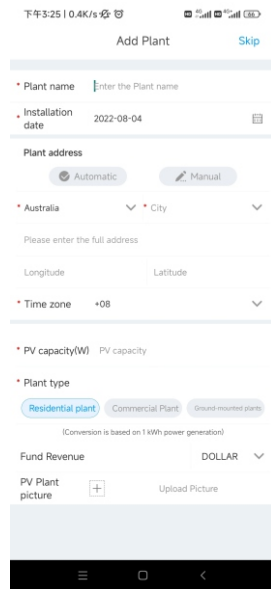

a) When customers add plant, they need to fill in the name of the plant (required), installation date (required), national city (required), detailed address (optional), time zone (required), PV capacity (required), plant type (required, Household plant/ Commercial plant/Ground plant), fund income (optional), plant picture (optional, when the user does not upload pictures, a default plant picture will be given).

b) There are two ways to fill in the plant address, automatic acquisition, and manual input. Automatic acquisition, through satellite positioning, obtain the current location of the user, then the detailed location will be filled automatically of the country .Manual input, the user manually input the country, city and detailed address.

c) This page can be skipped. After skipping, the user registration account will be logged directly, enter the APP plant page. Skipping the process of adding plant, the default plant will not be generated. When enter the APP plant page, the system will remind the user to add the plant.

4.3 Sign in and log out

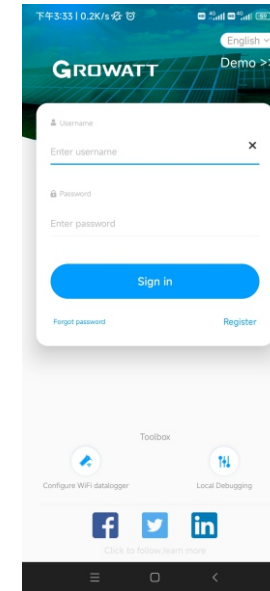

The user can log in the APP through the existing account and password. The system automatically determines the account's attributes and distributes the server. The ShinePhone system is divided into China and Worldwide servers.

After the users log in successfully, for the next time log in, you can directly select the account number from the information the phone remembered.

5. EV Charger Internet Configuration

For new users, please click the "+" in the upper right corner of the overview, select "GroHome" and add device (EV Charger), for users who already have had "GroHome" page, go to the "GroHome" page directly and click the "+" in the upper right corner to add device (EV Charger)

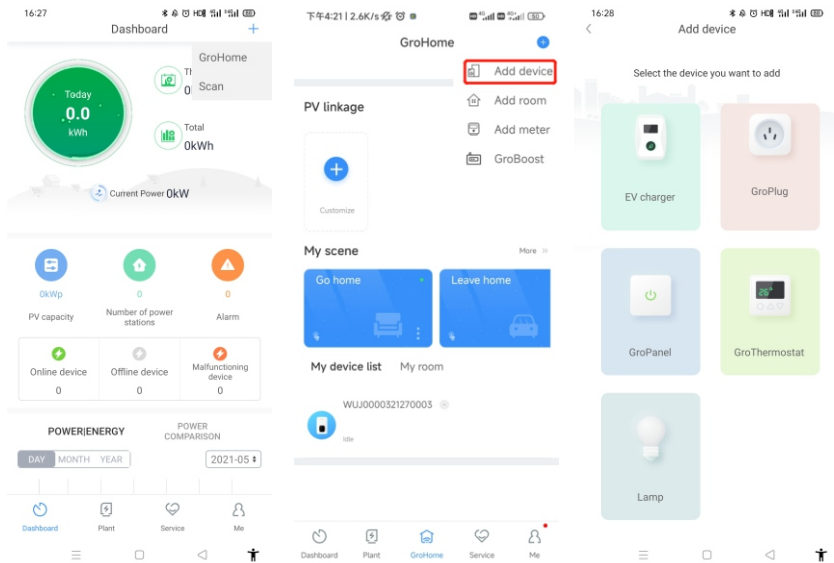

5.1 WiFi Configuration

- Choose a related power plant after adding the device (Note: a power plant is required to build before adding the EV Charger)
- Enter the serial number of the EV charger or scan the Bar/QR code to add the EV charger
- Select "WiFi" for network configuration
- Enable the "WLAN" in the setting and connect to the "WIFI" whose name is consistent with the serial number of the EV charger, then enter the WiFi password (default WiFi password is: 12345678) and click "next"
- Enter the WiFi name and password of your router (the connected WiFi is required 2.4GHz WiFi, and the network should be available), and then click "Next"
- Please wait 2-5 minutes and refresh the EV charger status to confirm whether the communication is successful

Note: If the EV charger has been configured before, then don't need to configure the network again.

If the users haven't build the "power plant" before and click "add device", the app will remind you to add a plant firstly, and the app will allow to "add device" after finishing filling the information of the plant .

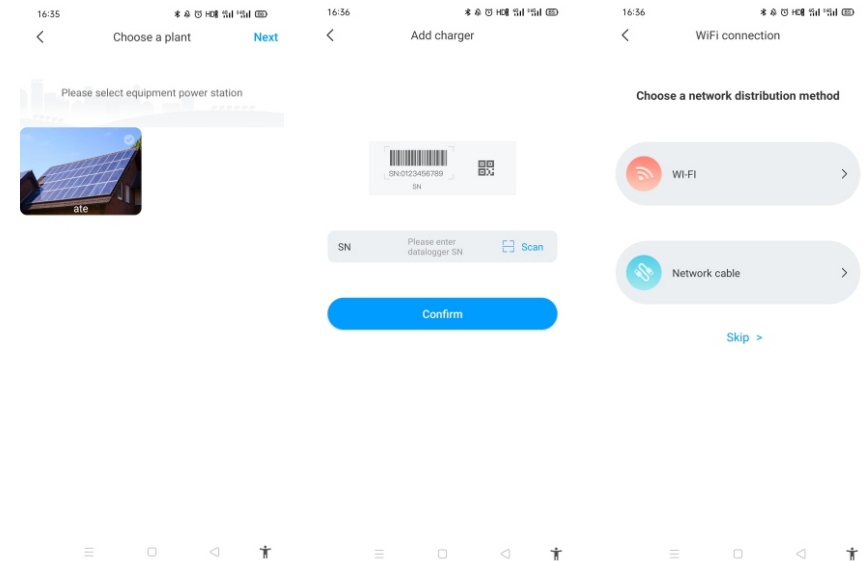
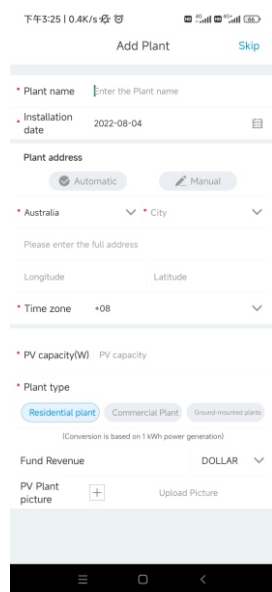
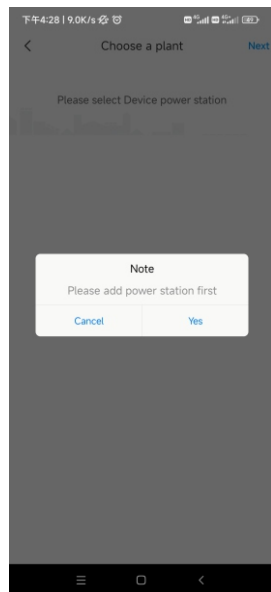

(a)

(b)

(c)

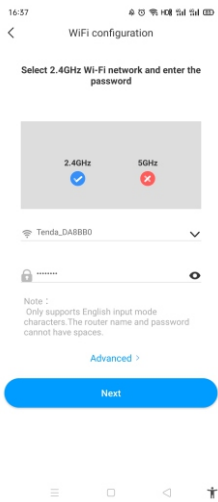

(d)

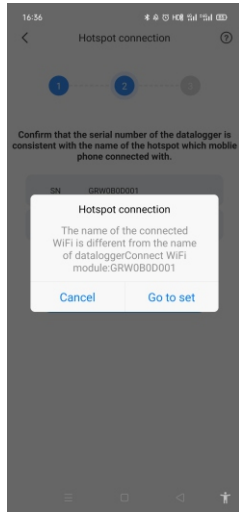

(e)

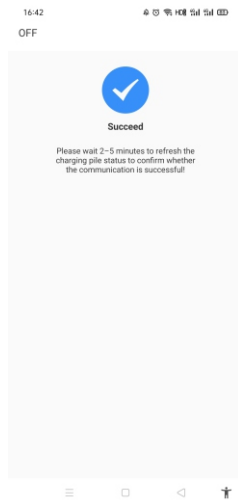

(f)

5.2 Network Cable Connection Configuration

- Choose a related power plant after adding the device (Note: a power plant is required to build before adding the EV Charger)
- Enter the serial number of the EV charger or scan the Bar/QR code to add the EV charger
- Select "Network Cable" for network configuration
- Click "cancel" and the network will be connected dynamically based on the dynamic IP mode.
- Waiting for 2-5 minutes which EV charger will refresh its status, and confirm whether the communication is successful

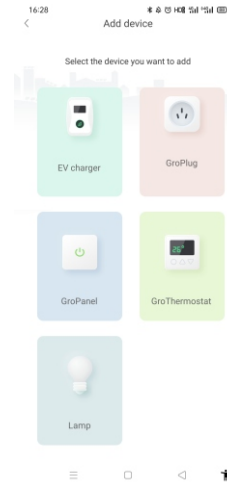

(a)



(b)

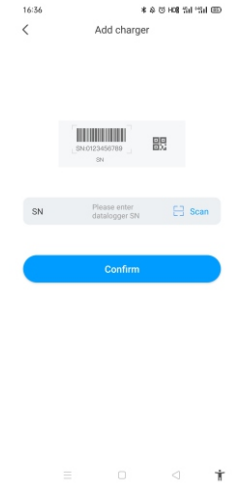

(c)

Advanced Setting

If the EV charger has an external current sensing device, then click the "advanced" in the WiFi configuration page, and choose the corresponding configuration (CT or meter type, choose the right brand of the meter type, SM-US-200)

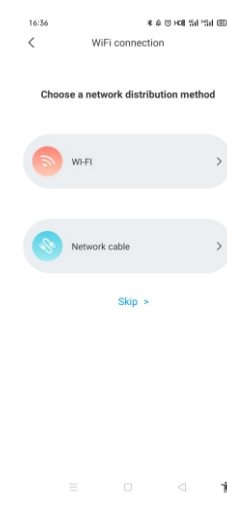
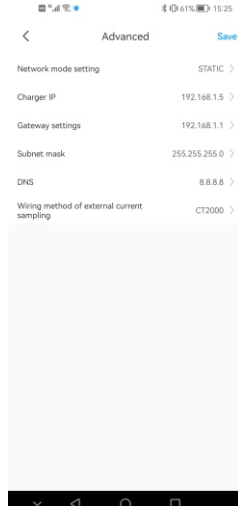
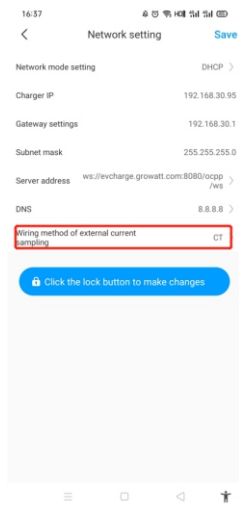
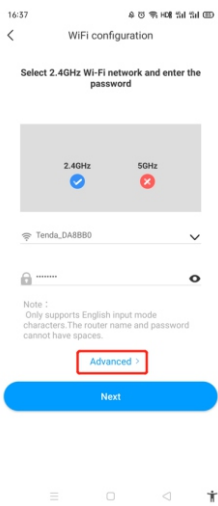

(d)

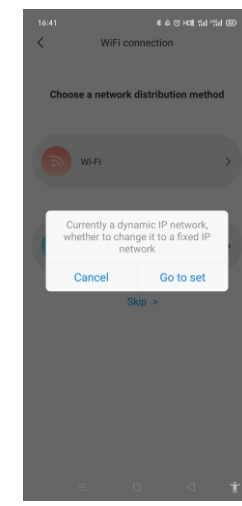

(e)

Note: If the users want to set the static IP mode

1. Click "go to set" during (d) step and make sure the network cable is disconnected
2. Do the hotspot connection, connect to the WiFi whose name is consistent with the series number of EV charger, and enter the default password:12345678
3. Make sure the parameters of IP and gateway are the same as that of the router and click "next"
4. Connect the network cable and wait for 2-5 minutes which EV charger will refresh its status, and confirm whether the communication is successful

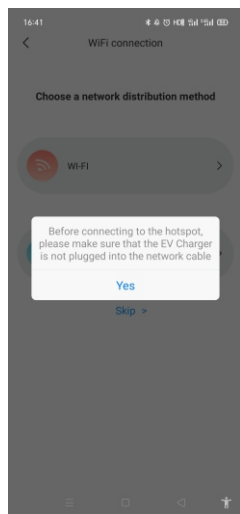

(1)

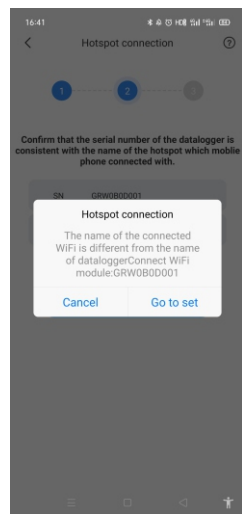

(2)

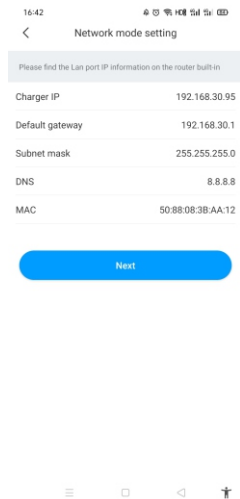

(3)

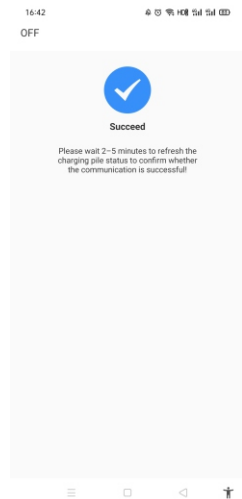

(4)

5.3 4G Configuration

If the EV charger is a 4G model, then the user can click the "skip" directly during the page of network configuration methods.

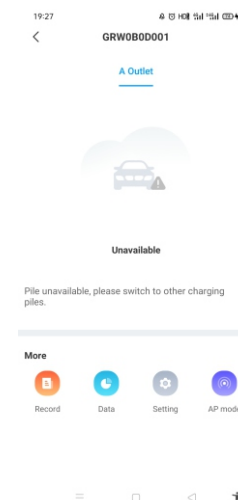
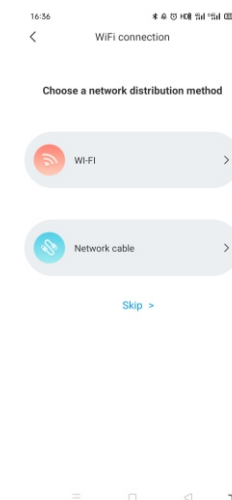
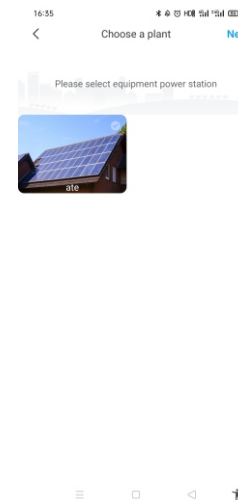
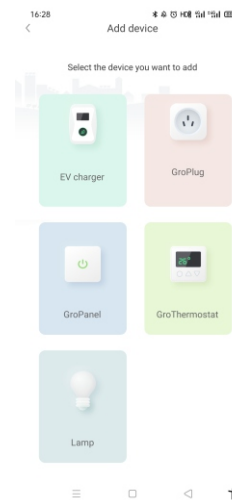

5.4 AP Mode Configuration

If the network connection is abnormal, the users can use the AP mode to reset the network or do some basic setting

a)Click the AP mode, and enter the hotspot connection, click “next” to switch to other pairing mode.

b)Connect the WiFi whose name is consistent with the series number of the EV charger and click next

c)User can check the basic information, and do some basic parameters setting like network setting, server setting and EV charger setting

d)After that, waiting for 2-5 minutes which the EV charger will refresh its status

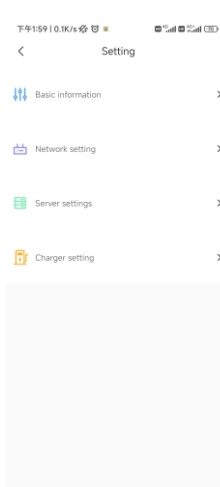
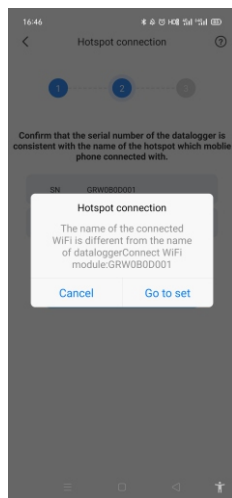
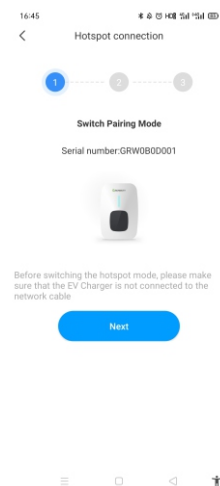
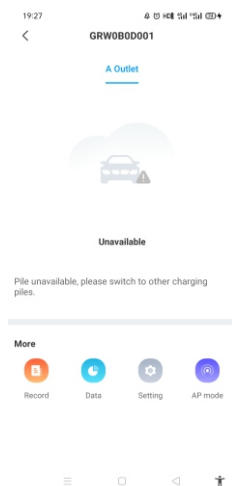

6. Operation instruction and LCD description

6.1 Charging mode and Operation

User can go to the “setting” page and click the “Charger setting”, to set the charging activation way like APP, RFID, plug and charge

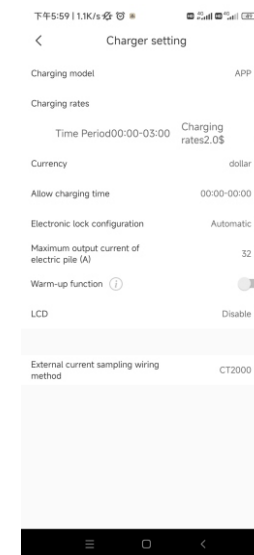
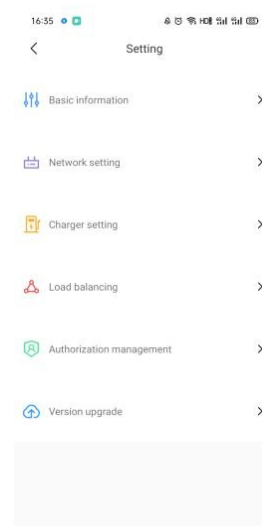

APPmode:

Initiate or cease charging by using APP. You can also use APP for reservations and choose the work mode you need.



APP mode operation process flow

Note:Network setting; connect to wifi;

The wifi name and wifi password should be entered manually .Before entering the wifi name or wifi password ,users should enter '000000' first and choose the item again to input the name or password of the wifi.

RFIDmode:

Charging can only be initiated or ceased by swiping RFID card.

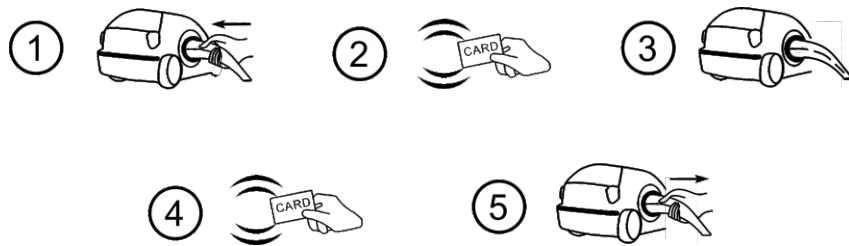

RFID mode operation process flow

Plug&Charge:

Charging will start automatically after EV plugged in. If you want to stop the charging, just press the forced on/off button on the side of the charger.

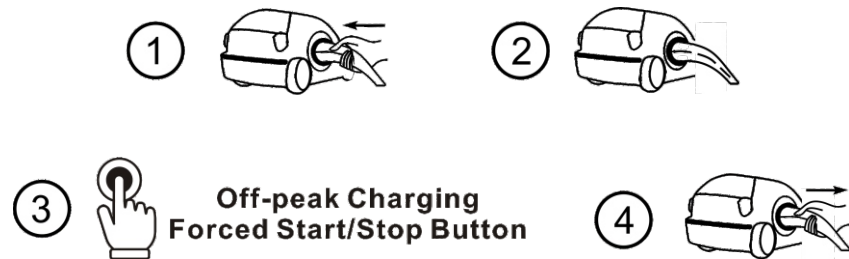

Plug&Charge mode operation process flow

6.2 LCD interface introduction

	<p>Interface of standby status. Charging mode is displayed at the bottom centre of the screen.</p>
	<p>Interface of user card information. Displayed for user to check card ID and balance when swiping RFID card while EV is not connected.</p>
	<p>Interface of charging status. Displayed when the charging is being carried out. There is charging time, consumed electricity, charging cost on it, as well as real-time charging voltage and charging current.</p>
	<p>Interface of charging complete. Displayed when the EV stops charging, or forced on/off button is pressed on charger side.</p>

7. EV Charger WorkModes

7.1 Introduction

Plug & Charge

Click “charge” directly and the EV will be charged at maximum power coming from a renewable energy source or simply from the grid, especially quick if you’re in a hurry, and support multiple control strategies of timer, charging capacity, charging budget.

Note: the reservation function can only be set when the EV charger is in idle status

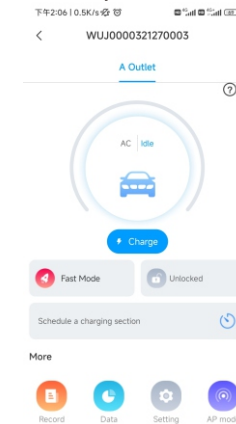

Time Reservation

It can be divided into charging time and charging period reservation, users can set when it will start to charge and how long the charging will continue, also can enable “every day” to make it work following that strategy to work all the time

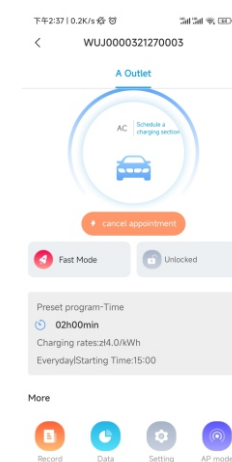
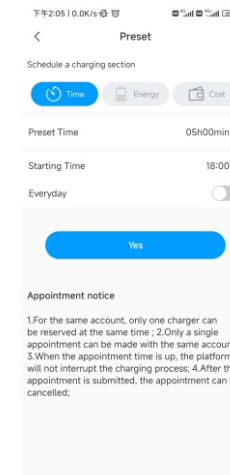

	<p>Interface of fault status. Displayed with fault code and fault description when fault occurs.</p>
	<p>Interface of reserved status. If the back-office server and APP support reservation function and the charger is reserved, this interface will come out showing user ID and remaining time to reserved time.</p>

Charging Capacity Reservation

Users can set the target charging capacity(kWh) and the start time through clicking “energy”, and also can enable “every day” to make it to work following that strategy to work all the time

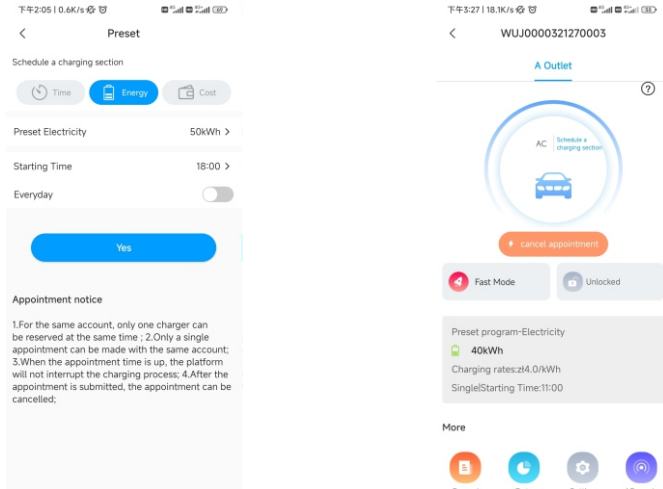

Charging Budget Reservation

Users can set the target charging budget and the start time through clicking the “cost”, and also can enable “every day” to make it to work following that strategy to work all the time

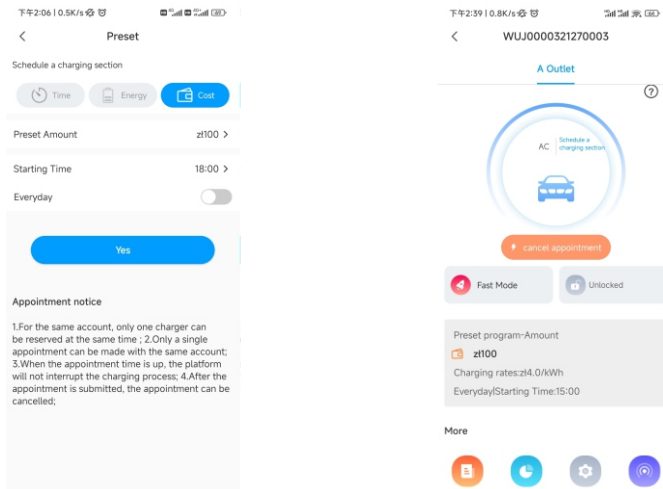

7.2 PV Linkage Mode

Introduction

Driven by solar, charge your car with renewable energy, the EV will be charged by the surplus solar power dynamically, combining PV and EV charger together to maximize the solar self-consumption rate and cut your bill.

Note: Under the PV-Linkage mode, the EV charger will automatically start charging when the surplus solar power is sufficient.

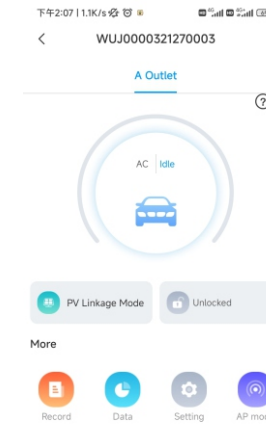

Wiring

To monitor the real-time power import and export from the grid, meter is required for this function to work properly

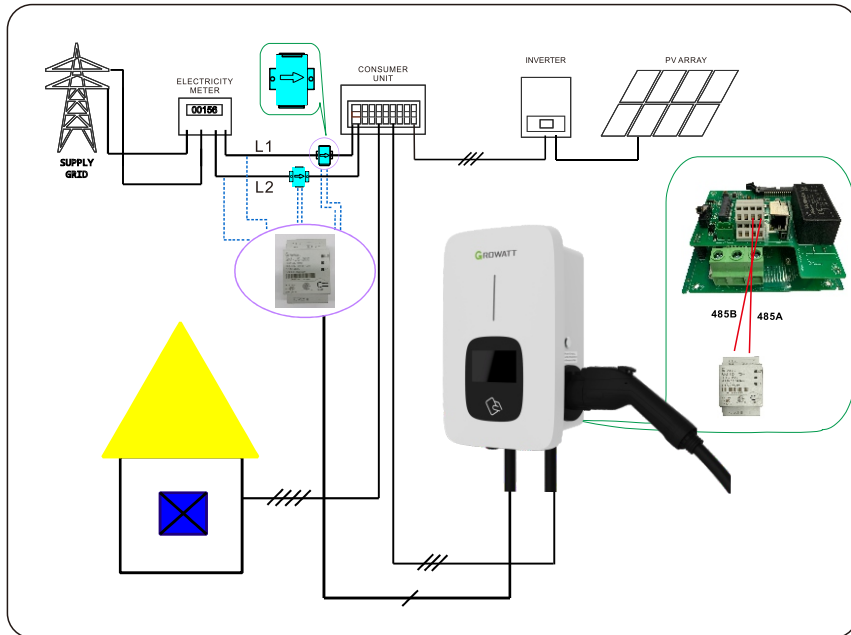

APP Operation

The PV linkage mode requires the EV charger to connect with an external current sensing device, and choose the corresponding configuration *(CT or meter type, choose the right brand of the meter type, SM-US-200

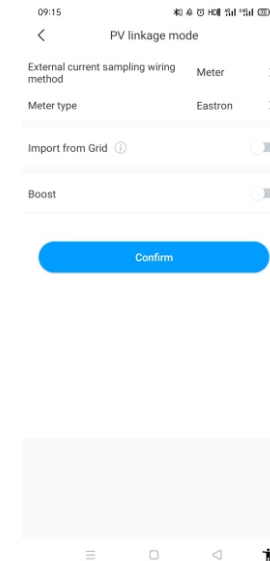

Note: Users can choose different meters to monitor the real-time power import and export from the grid. For American EV charger, the meter would be SM-US.

Function of importing from the grid

Disable the function of importing power from the grid

The EV will be charged dynamically only by surplus solar power when the surplus solar power is greater than Min. operation power*. When surplus solar power is lower than Min. operation power, then the EV charger will stop charging.

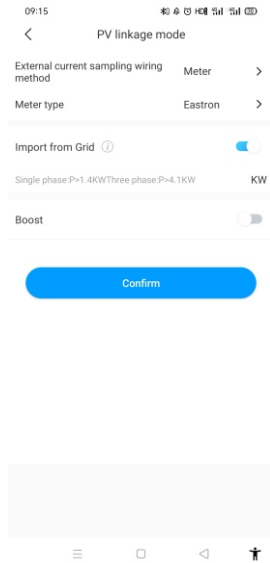

Enabling this function will allow the EV charger to take power from the grid. During the solar power insufficient period, the EV charger will operate according to the default minimum charging power. For single phase EV charger the default value is 1.4kW. As for three phase EV charger, it's 4.1kW. Once allowing the power take from the grid and set P(kW) value. For single-phase, $P < 1.4\text{kW}$; For three-phase, $P < 4.1\text{kW}$; When the excess solar power is greater than $(1.4 - P)\text{kW}$ or $(4.1 - P)\text{kW}$ value, the charger will start and charge at the power of 1.4kW or 4.1kW; For single-phase $P \geq 1.4\text{kW}$; For three-phase $P \geq 4.1\text{kW}$; the charger will start directly and charge at the power of P(kW). If the excess solar power is greater than P value, the charging power will follow the excess solar power.

Note: *Min. operation power: 1.4kW for single phase EV charger, and 4.1kW for three-phase EV Charger

Boost Function

● Manual Boost Function

It is useful if users arrive home with an almost empty battery and users want to charge the EV quickly to ensure enough energy for a short trip when the solar energy is insufficient.

While users enable the manual boost function and set "start time" and "end time", the EV charger will charge the EV at its max. power during a set period even drawing the power from the grid, after that, it will recover back to the normal PV linkage mode.

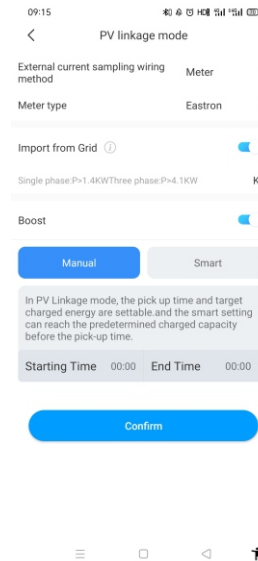

● Smart Boost Function

It's useful to guarantee EV's battery capacity before a set time when the solar energy is insufficient.

While users enable the smart boost function and set "Pick-up time" and "Preset electricity", the EV charger will charge the EV with a target kWh figured by a set time, it may draw the power from the grid to guarantee the EV's battery capacity when the solar energy is insufficient.

Example: if the users enable smart boost and set the "pick-up time" is 22:00, and "preset electricity" is 20kWh. In sunlight hours, the EV has been charged by surplus solar energy with the only 10kWh of charge accumulated, because users activated the smart boost, then the THOR EV Charger will automatically boost the charge to the required 20kWh by 22:00 even taking power from the grid.

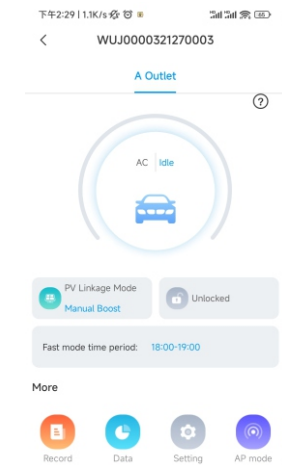

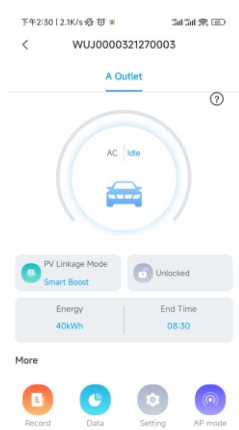
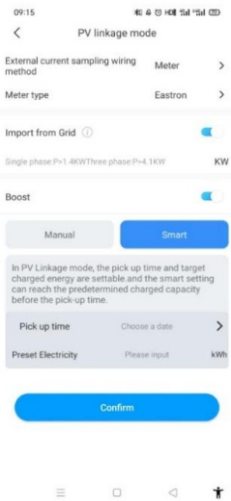

Smart Boost Function

It's useful to guarantees EV's battery capacity before a set time when the off-peak time is not long enough.

While users enable the smart boost function and set “pick-up time” and “preset electricity”, the EV charger will charge the EV with a target kWh figured by a set time, it may draw the power from the grid to guarantee the EV's battery capacity when the off-peak time is not long enough.

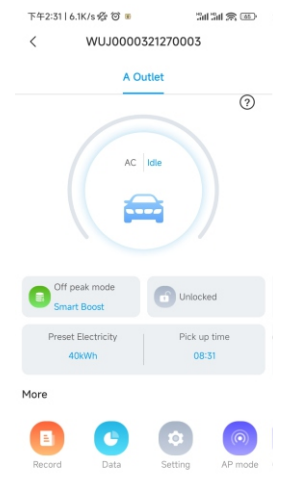
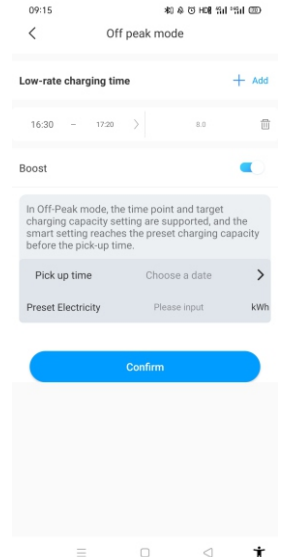

7.3 Off-peak modes

Introduction

Once enable the Off-Peak mode, the EV charger will automatically charge the EV when it's at off-peak time to reduce the electricity bill. Users also can customize their low-rate charging time in the off-peak mode page

Note: Users need to input the charging rates in the setting page manually before enabling off-peak modes

Note: Under the Off-peak mode, the EV charger will automatically start charging at the low-rate charging time.

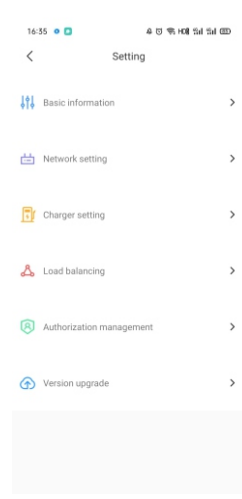
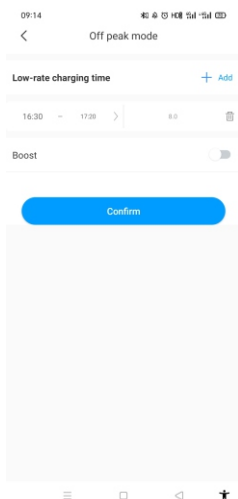
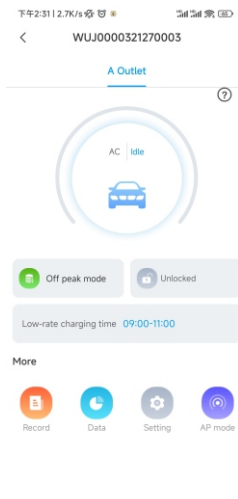

7.4 Load balancing function

The EV charger can read the incoming power to the house with an additional Meter. Then the EV charger will adjust its charging power dynamically according to the home power to avoid exceeding the limited point, always charge your car at the maximum charging speed without triggering the power limitation.

Note: The load balancing function require an external Meter, and please follow the wiring method of PV linkage mode.

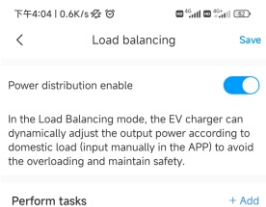
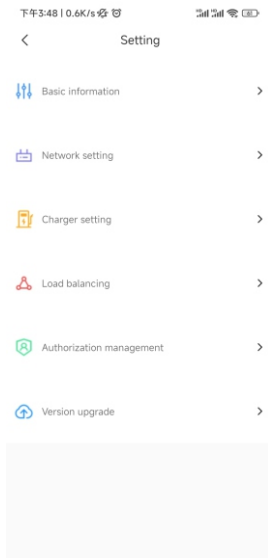

Perform tasks + Add

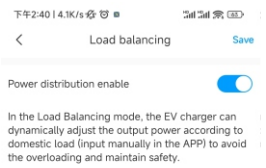
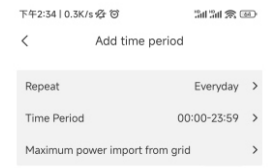

Perform tasks + Add

- Time Period1 >
- 00:00-23:59
- Everyday | 3KW
- Time Period2 >
- 00:00-23:59
- Everyday | 5KW

Save

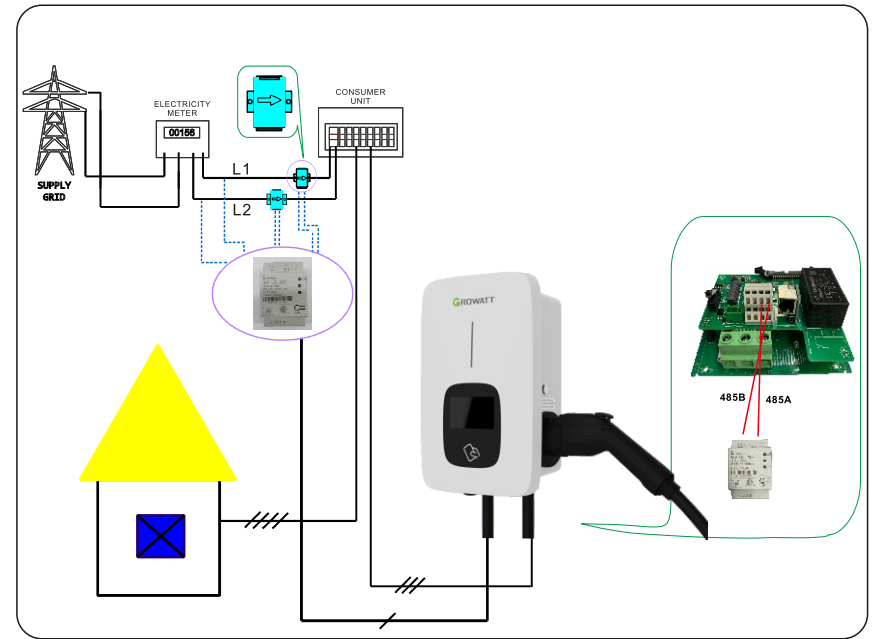

8. Other Settings

The setting page includes basic information, network setting, pile setting, load balancing and authorization management.

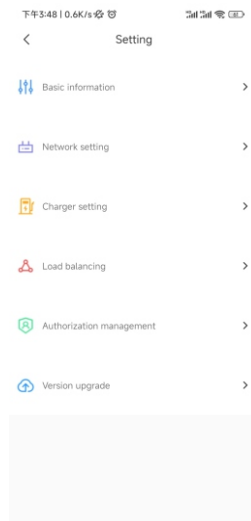

●Basic information: EV charger ID, EV charger name, country and city, version number.

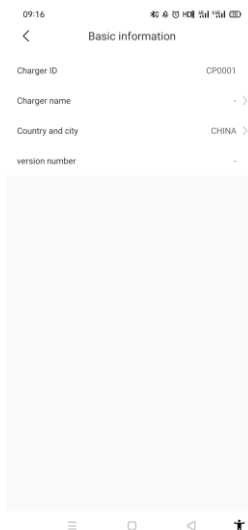

Network setting: network connection method, network mode setting, gateway settings, subnet mask, DNS address

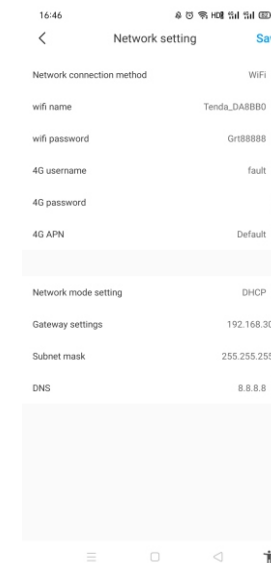

●Charger setting:

- 1) Charging activation: users can set the charging activation way like APP, RFID, plug and charge
- 2) Charging rates: users can set their charging fees, which could be used for the calculation of electricity cost and off-peak mode.
- 3) Currency:Users can set the currency to calculate the budget etc.
- 4) Allow charging time: user can use it to limit the time to use the EV charger.
- 5) Maximum output current of the EV charger: users can use it to limit the max. power output from the EV charger.
- 6) Warm up function:In the case of extremely cold weather,the EV mostly needs to preheat and defrost after starting.Once the warm-up function is enabled,when the EV is fully charged,the EV charger will preheat the EV,which can reduce battery consumption.
- 7) LCD:users can disable or enable the LCD.
- 8) External current sampling wiring method:When CT meter is used,the external current sampling wiring method should be CT2000 or CT3000.When direct connection meter is used,the external current sampling wiring method is METER.

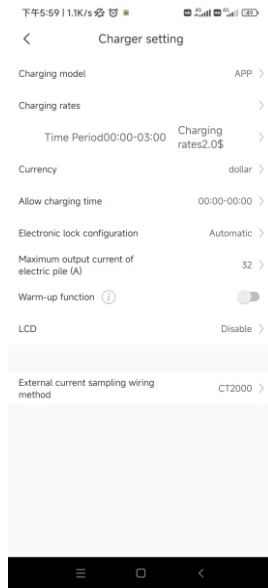

•Authorization management:

Permissions: it's useful for authorization management, add and authorize the other account which can use the EV Charger directly

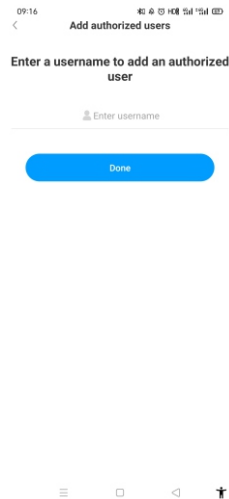
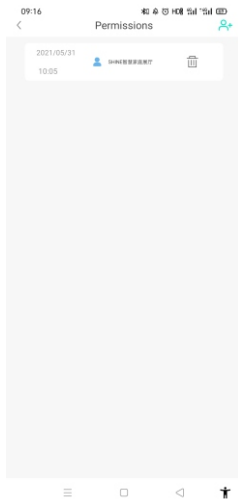

•Version upgrade

Users can check the latest version of the inverter's firmware and the current version they are used now. If there is a new version, users can upgrade by clicking the 'Upgrade'.

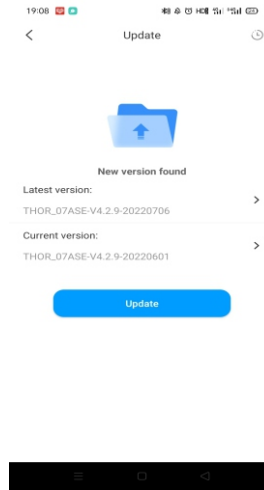

9. Record

a)Charging record:

Display the serial number of the EV charger, number of the charging gun, start time, end time,charging time, charging cost, charging capacity, and self-consumption rate

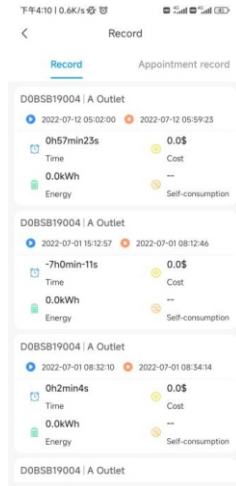

b)Appointment record:

Display the list of charging schedules that have been set before.

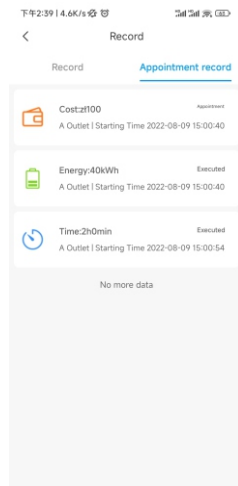

10.Data

The users can read the total charge capacity(kWh) and cost, also the self-consumption energy and rate by day, month, and year.

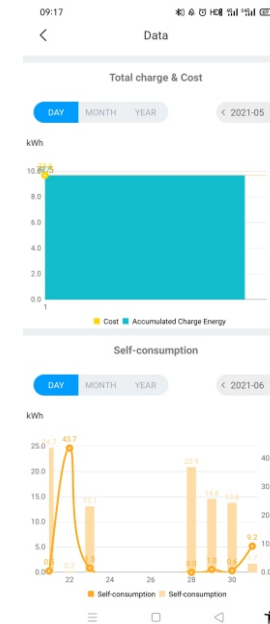

11. Configuration through internal web (Service Tool)

After the installation and wiring is done, connect the Charger to a computer and configure parameters via the web browser of the computer, then the Charger can be ready for use.

11.1 Set computer's IP

The Charger's default IP address is 192.168.1.5. To access the parameter setting interface, you'll need to first set the computer's IP to 192.168.1.x(x can be any value between 1 and 255 except for 5, e.g. 192.168.1.10).

To set a static IP on your Windows computer:

1. Click Start Menu > Control Panel > Network and Sharing Center. (For Windows 8 and higher, search for and open Control Panel and select Network and Internet).

2. Click Change adapter settings.

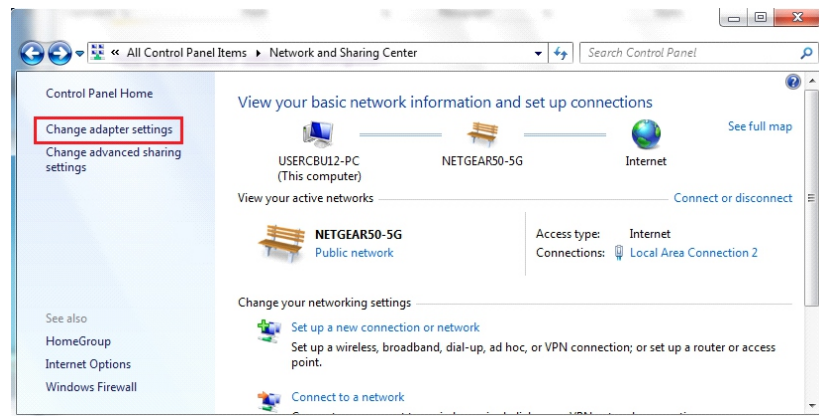

3. Right-click on Local Area Connection and click on Properties.

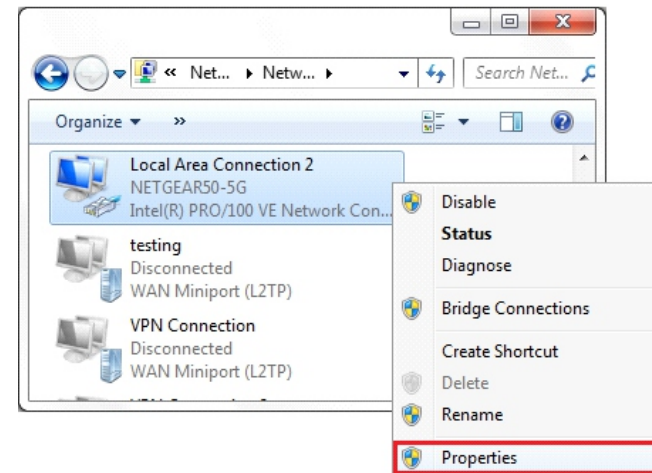

4. Select Internet Protocol Version 4 (TCP/IPv4) and click on Properties.

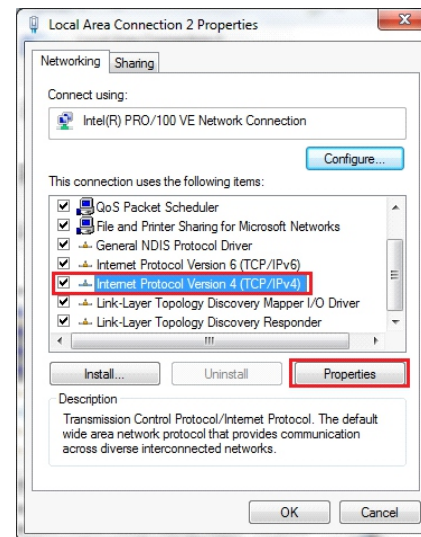

5. Select "Use the following IP address" and enter the IP address, Subnet Mask, Default Gateway. Click OK and close the Local Area Connection properties window.

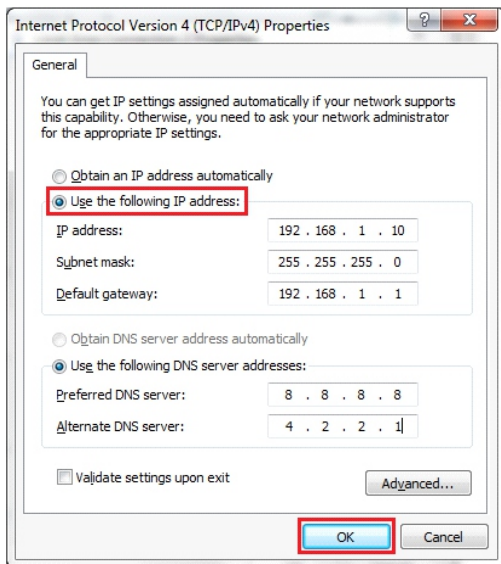

11.2 Configure parameters

Connect the charger to a computer via a network cable. Open the web browser and type in <http://192.168.1.5:8080/> in the address field and click enter, then the parameter setting page of the charger will open up.

Parameter setting can only be done via web browser on a computer. It is suggested to use IE or Firefox, other browser might have compatibility problem.

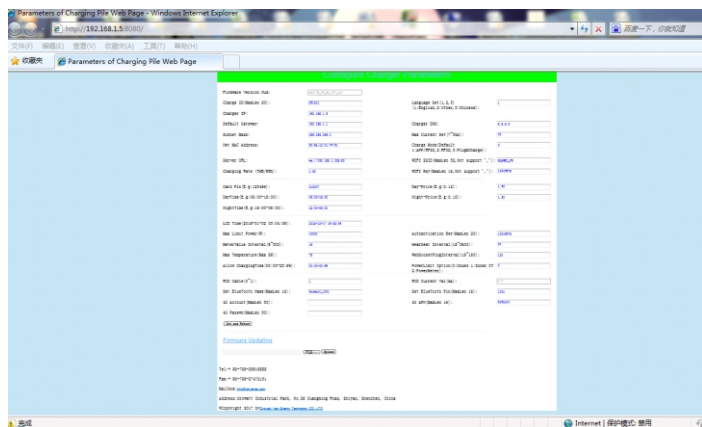

Overview of Parameter setting page

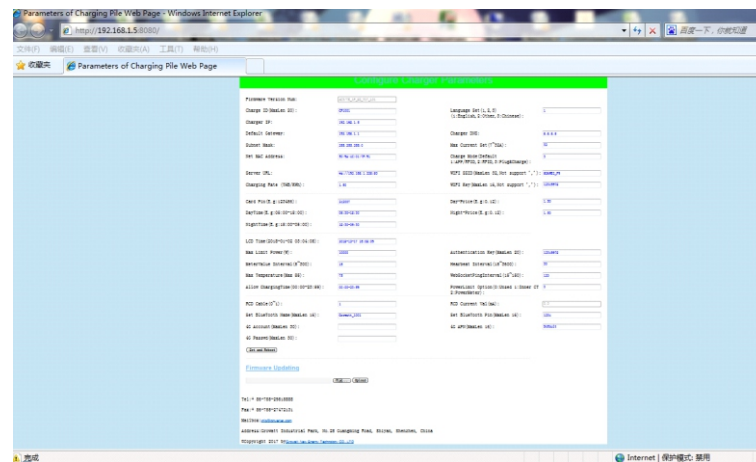

Overview of Parameter setting page

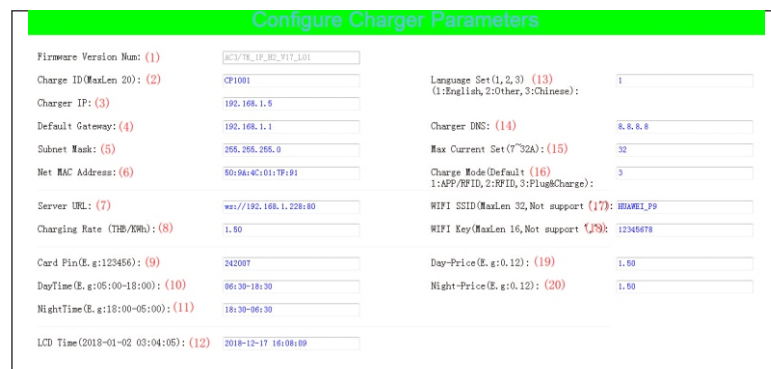

Enlarged view of parameter setting page_1

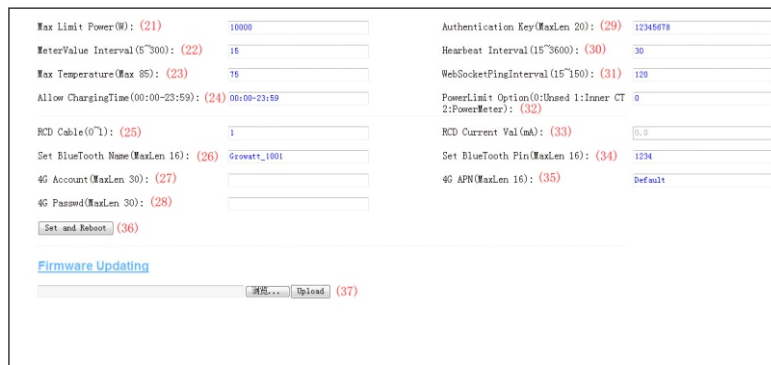

Enlarged view of parameter setting page_2

Explanation of parameters:

(1) Firmware version of the Charger. This item cannot be modified here on the setting page.



Firmware Version Num: (1)

Fig.1

(2) Charger ID, this is the unique identification of the Charger. If the charger is to be connected to Growatt back-office server, this ID must be set as the serial number on the nameplate of the Charger. Otherwise the Charger cannot be registered on the server.



Charge ID(MaxLen 20): (2)

Fig.2

(3) Charger IP. The default IP is 192.168.1.5. It is not suggested to change the default IP. If you have changed the default IP and forgot the new IP, you can reset the charger to factory setting by long press the reset button(the reset button on control board, not the red emergency stop button) until the charger reboot. Then you can use the default 192.168.1.5 for access.

Please note: After restoring the charger to factory setting, you'll need to reset the charger ID(same as serial number, can be found on the nameplate sticker) and server url, otherwise the charger won't be connected to the back-office server.



Charger IP: (3)

Fig.3

(4) Charger gateway. The default value is 192.168.1.1. It is not suggested to change. If the gateway has been reset to other value and you have forgotten the new value, you can restore the charger to factory setting by long press the reset button.



Default Gateway: (4)

Fig.4

(5) Charger Subnet mask. The default value is 255.255.255.0. It is not suggested to change. If the subnet mask has been reset to other value and you have forgotten the new value, you can restore the charger to factory setting by long press the reset button.



Subnet Mask: (5)

Fig.5

(6) MAC address. This is the MAC address used for LAN cable connection. If the charger is connected to Growatt back-office server via LAN cable and the router has MAC access control, then you can put this MAC in the router to allow the charger to access server



Net MAC Address: (6)

Fig.6

(7) Server URL is to set the domain name or IP address of the back office server to be connected.

The domain name of Growatt server is "ws://evcharge.growatt.com:8080/ocpp/ws"; IP address is "ws://192.168.1.5:8080/ocpp/ws".

Authentication Key and Heartbeat Interval is used for testing and no need to reset.



Server URL: (7)
Authentication Key(MaxLen 20): (29)
Heartbeat Interval(15~3600): (30)

Fig.7

(8) Charging fee per unit of electricity.



Charging Rate (THB/KWh): (8)

Fig.8

(9) PIN of the charger, used to verify the PIN of user card. To use a RFID card with the charger, their PIN must be consistent. If the user card has a different PIN, then it cannot be used on this charger. The default PIN setting of the charger is 242007.

Card Pin(E. g:123456): (9)

Fig.9

(10) Peak time period. Set the time period of peak tariff.

DayTime(E. g:05:00-18:00): (10)

Fig.10

(11) Off-peak time period. Set the time period of off-peak tariff.

NightTime(E. g:18:00-05:00): (11)

Fig.11

(12) Time of the charger. Set according to the local time. After the charger is connected to back-office server, the time will be synchronized with the server's time. If the charger has no server connection, then you'll have to reset the time every time you turn off and back on the charger.

LCD Time(2018-01-02 03:04:05): (12)

Fig.12

(13)Language of LCD screen.

Language Set(1, 2, 3) (13)
(1:English, 2:Other, 3:Chinese):

Fig.13

(14) Charger DNS setting, this only needs setting when the charger is to connect to server via LAN cable.

Charger DNS: (14)

Fig.14

(15) Set the max output of the charger.

Max Current Set(7~32A): (15)

Fig.15

(16) Charging mode setting. 1: APP/RFID mode; 2: RFID mode; 3: Plug&Charge mode.

Charge Mode(Default (16)
1:APP/RFID, 2:RFID, 3:Plug&Charge):

Fig.16

(17) (18) WiFi SSID(wireless network name) and WiFi Key(WiFi password) is used for WiFi connection.

WIFI SSID(MaxLen 32, Not support (17):
WIFI Key(MaxLen 16, Not support (18):

Fig.17

(19) (20)Set peak tariff and off-peak tariff.

Day-Price(E. g:0.12): (19)
Night-Price(E. g:0.12): (20)

Fig.18

(21) (32) (22) Max power import to the property, Power sampling device selection, meter value collection interval. These 3 parameters are used for power management setting.

Max Limit Power(W): (21)
PowerLimit Option(0:Unused 1:Inner CT 2:PowerMeter): (32)
MeterValue Interval(5~300): (22)

Fig.19

(23) Over temperature protection value, not suggested to change.



Fig.20

(24) Charging-allowed time. Charging can only start within this time period. This is used for off-peak charging setting.

If you want to charge out of this period, just press the forced on/off button at the side of the charger.



Fig.21

(25) DC residual current sampling value calibration. Enter 0 and press "Set and Reboot" to calibrate the DC RCD ring.



Fig.22

(26) (34) Bluetooth setting. Only needs setting when the charger is equipped with Bluetooth.



Fig.23

(27) (28) (35) 4G connection setting.

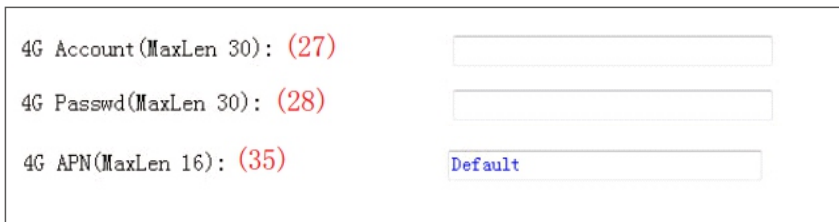

Fig.24

(31) This is for communication testing, no need to reset.



Fig.25

(33) DC residual current real-time detection value.



Fig.26

(36) Press this button for the parameter change to take effect.



Fig.27

(37) This is used to upgrade firmware.



Fig.28

There are 2 ways to update firmware for EV charger

1. Update by SD card
2. Update on parameter setting page

11.3 Update by SD card

The firmware file must be named as “App.bin”.

1. Prepare a microSD card with capacity not greater than 4G. Format the SD card using FAT32.

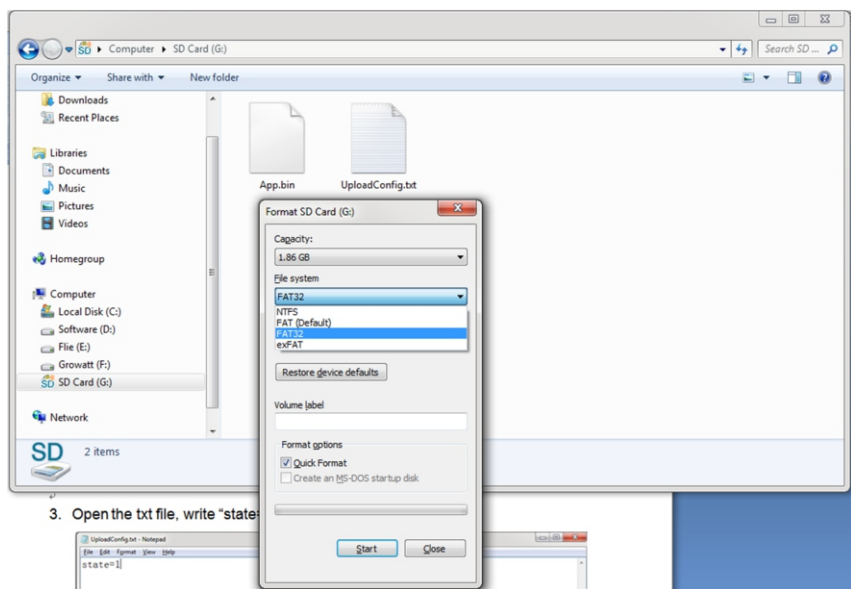

2. In the root directory of the SD card, rename the firmware file as “App.bin”. And create a txt file with name of “UploadConfig.txt”.

App.bin	2018/12/5 15:58	BIN 文件	168 KB
UploadConfig.txt	2018/12/6 15:04	文本文档	0 KB

3. Open the txt file, write “state=1” in it and save the file.

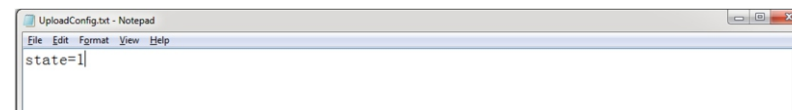

4. Insert the SD card into the charger, turn off and back on the charger, the update will start automatically. The indicator will first flash red and then flash green with a long beep as the end of the update(sometimes the beep sound may not be clearly heard). After the update is done, turn off the charger and remove the SD card.

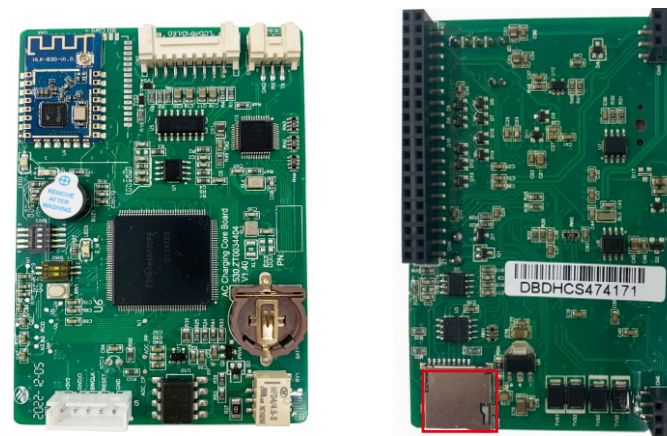

Micro SD slot of charger

5. Check the current FW version on LCD or the parameter setting page.

To check FW version on the parameter setting page

Connect the charger to computer via a network cable, the computer's IP must be within the 192.168.1.x segment(x is any value between 1 and 255 except 5).Open the web browser, type in the charger's default IP of “http://192.168.1.5:8080” and click enter, then you can check the firmware version on the appeared parameter setting page.

Configure Charger Parameters

Firmware Version Num:	AC22/44K_1P_H3_V52_L01	Language Set(1,2,3) (1:English,2:Chinese,3:Other):	1
Charge ID(MaxLen 18):	CP2007	Max Output Current Set(7~63A):	32.00
Authentication Key(MaxLen 20):	12345678	Charge Mode(Default 1:APP/RFID,2:RFID,3:Plug&Charge):	3
Charger IP:	192.168.11.196	WIFI SSID(MaxLen 32,Not support ','):	best
Default Gateway:	192.168.11.254	WIFI Key(MaxLen 16,Not support ','):	NONE
Subnet Mask:	255.255.255.0	Charger Time(2018-01-12 16:02:35):	2019-07-09 03:54:58
Net MAC Address:	0a:0b:de:9f:ab:cd	Operators APN:	default
Server URL(MaxLen 100):	ws://charge.growatt.com/80ocpp/w	Sensor Monitor Max Power(3~45KW):	45
Charging Rate (Per KWh):	1.00	BlueTooth Name(MaxLen 16):	Growatt_0001
Card Pin(6 digits, E.g:123456):	242007	WebSocketPingInterval(15~150 Sec):	120
Charger DNS:	8.8.8.8	Hearbeat Interval(15~3600 Sec):	300
BlueTooth Pin(MaxLen 16):	1234	Type B RCD(Enter 0 calibration):	-0.07
MeterValue Interval(5~300 Sec):	15	Type B RCD Protection:	4
Max Temperature(Max 85):	80		

11.4 Update on parameter setting page

Using this method for update doesn't require any specific name for the firmware file.

1. Connect the charger to a computer with IP address set as 192.168.1.x(x can be any value between 1 and 255 except 5) via a network cable. Open web browser and type in the charger's default IP address—http://192.168.1.5:8080, click enter then you'll get into the parameter setting page.

2. Scroll down to the below field.

Firmware Updating

D:\Desktop\App.bin

3. Click the "Browse" button and select the firmware file. Click "Upload", then update will start automatically.

Firmware Updating

D:\Desktop\App.bin

During the update, the LED indicator will behave as below,

First flash red and goes out with a short beep sound, during this period the firmware file is transmitted to the charger's flash memory from the computer;

Then flash red again for some seconds and quickly change to green light flashing. During this period, the charger is updating the firmware to its micro controller.

When the greenlight goes out, there will be a long beep sound. That means the firmware is successfully updated.

The beep sound may not be audible with the front cover fixed on the charger.

If the update doesn't start after click "Upload", Turn off and back on the charge to try again.

4. You might see below content. If the charger is already successfully reboot after the firmware update, close the browser and open it again to check the current firmware version.

192.168.1.5:8080/firmware.cgi

please wait for a while, the module will boot in 2 seconds.

192.168.1.5:8080/firmware.cgi

please wait for a while, the module will boot in -13 seconds.

12. Troubleshooting

12.1 Troubleshoot by LED behavior or LCD display

If fault occurs, users can check the fault information on the LCD or by the number of blinks of the LED indicator light. Each fault is indicated with a sequence of different numbers of LCD blinking. A pause of 3 seconds between each sequence indicates the beginning or end of a sequence. If multiple faults happen at the same time, each sequence of blinking shows in chronological order at an interval of 3 seconds.

Please see the table below for detail information

No.	Fault code on LCD (if available)	Number of blinks of the LED	Fault description
1	100	3	The red emergency stop button is pressed or broken
2	105	1	Over voltage on phase L1
3	106	2	Under voltage on phase L1
4	108	4	Over current
5	109	5	Over temperature
6	110	6	leakage current detected
7	111	7	RS485 communication fault
8	112		Reserved
9	113	9	
10	114	10	Relay fault
11	115	11	PE fault
12	116	12	
13	117		Reserved
14	1000		Other fault

12.2 Firmware update fails

12.2.1 Firmware update failure with SD card:

- Check if the capacity is over 4G bytes, please use a SD card of less than 4G to retry;
- Check if the SD card is formatted with FAT32;
- Check if the firmware file is renamed as App.bin;
- Check if you have filled in "state=1" in the UploadConfig.txt file.

12.2.2 Firmware update failure with laptop:

Please try with IE browser. Or reboot the laptop to retry.

12.3 WiFi connection&APP issue

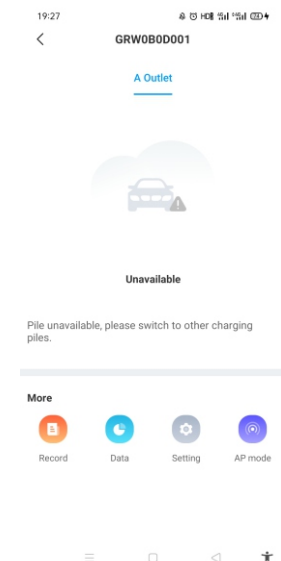

a. Please check and input the correct WiFi SSID and password to retry;

If you check the WiFi setting on the APP, please turn off and back on the charger and connect your mobile to the WiFi emitted by the charger for checking and setting.

b. Check if there is access control in the router, e.g. MAC filtering, port blocking, etc.

To verify this, you can use your mobile phone to create a hotspot and try to connect the charger to this mobile hotspot. If charger can connect to the hotspot, but cannot connect to the router, there must be access control in the router, please check with the site owner for this.

Check if charger is connected on Device list of the hotspot setting page

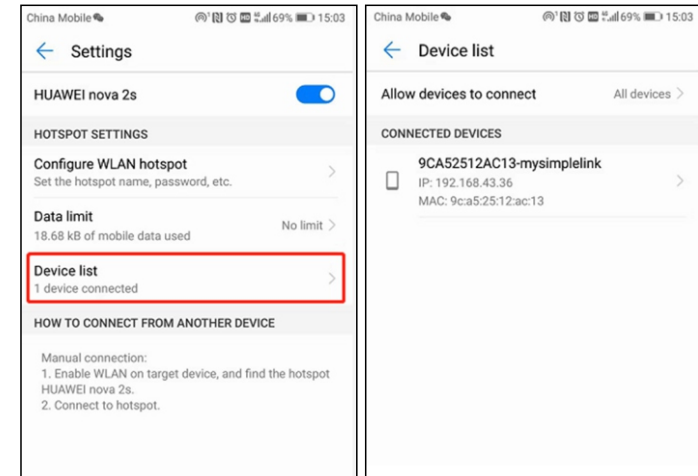

c. 1. Some routers have 2 WiFi, one is 2.4GHz, the other is 5GHz. Most homes just use the 5GHz WiFi as their default WiFi. But the charger can only connect to the 2.4GHz WiFi. So if the charger can connect to your mobile phone hotspot, but cannot connect to the home WiFi. Please check with the home owner or check on their router to see if you are using the 5GHz WiFi. Please do use the 2.4GHz WiFi for charger connection.

2. When the WiFi signal strength is lower than -75dbm, the charging point will not be able to connect with WiFi.

(1) Download the WiFi signal strength test tool from the app store to check whether the WiFi signal strength connected to the charging point is greater than -75dbm.

(2) If the WiFi signal strength is weak, it is recommended to use AP repeater to increase the signal strength, which can enlarge the WiFi signal range.

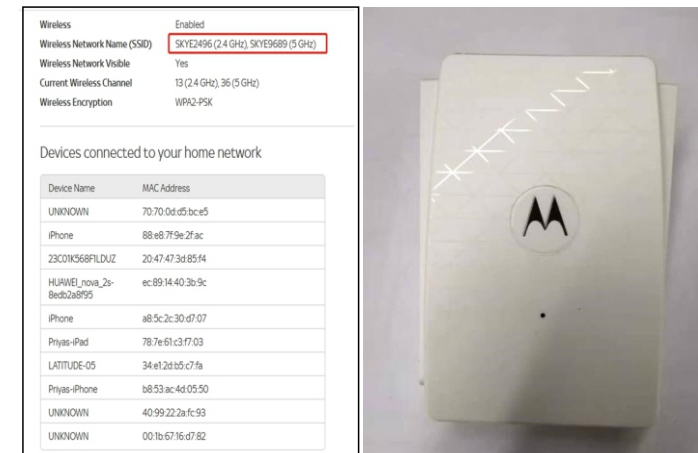

d. Check if the charger is still connected to the computer. Please unplug it from computer otherwise the charger won't connect to the back-office server.

e. Check if server address is correct in the "Server URL" field. The correct setting is :
ws://ess-charge.atesspower.com:80/ocpp/ws

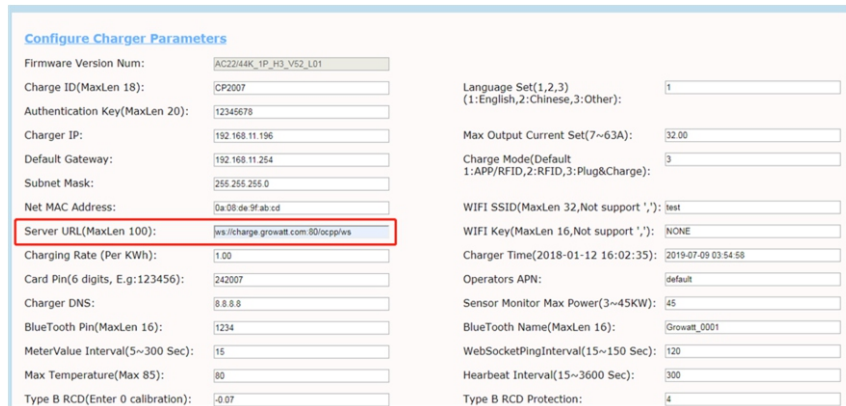

12.4 Cannot accessparameter setting page

a. Check if you have connected the charger to your computer,

b. Check if you have change the computer's IP to 192.168.1.x(x can be any value between 1 and 255 except 5).

To set a static IP on your Windows computer:

(1). Click Start Menu>Control Panel>Network and Sharing Center. (For Windows 8 and higher, search for and open Control Panel and select Network and Internet).

(2). Click Change adapter settings.

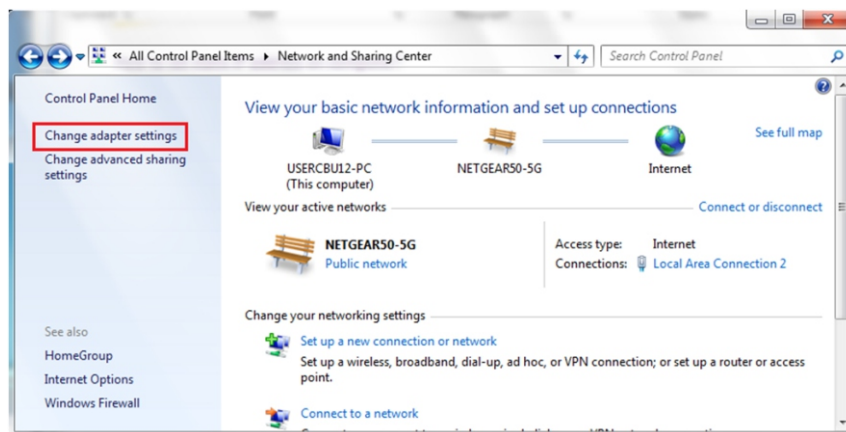

(3). Right-click on Local Area Connection and click on Properties.

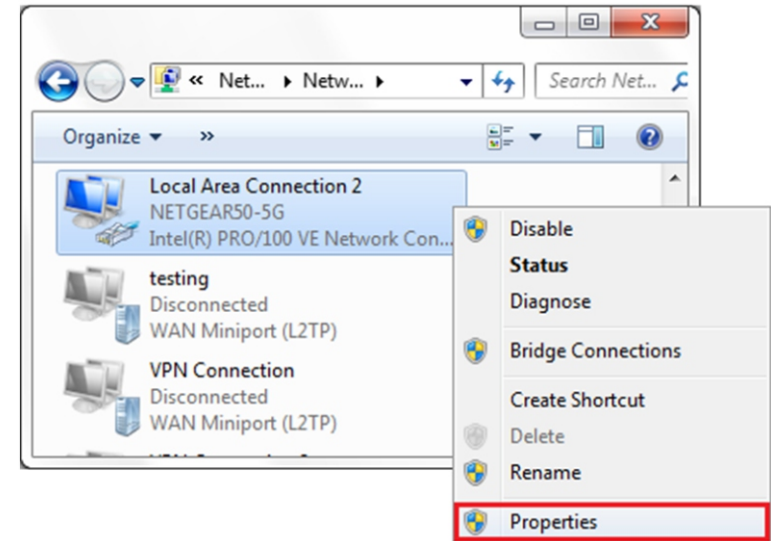

(4). Select Internet Protocol Version 4 (TCP/IPv4) and click on Properties.

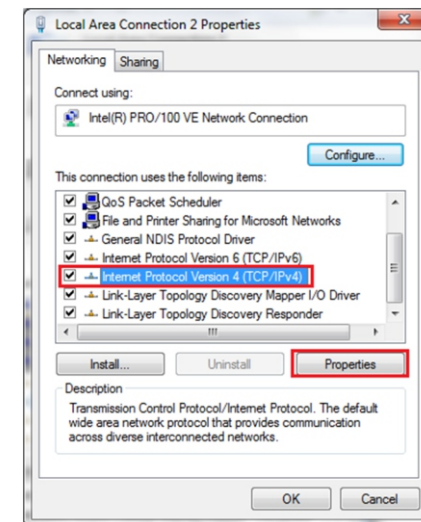

(5). Select "Use the following IP address" and enter the IP address, Subnet Mask, Default Gateway. Click OK and close the Local Area Connection properties window.

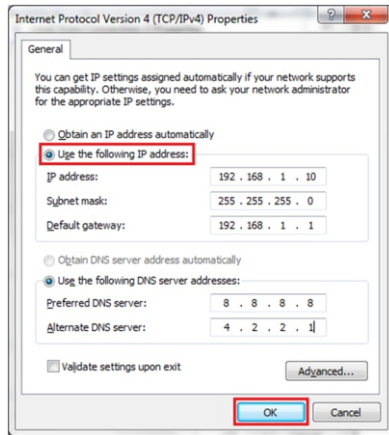

- c. Check what web browser is being used, it's suggested to use Firefox or IE, Chrome cannot be used to update firmware.
- d. Check if you have input the complete content, which is http://192.168.1.5:8080, in the address field, do not leave out the http:// or the ":8080".
- e. Sometimes you may need to restart the charger to access its parameter setting page.
- f. If you have changed the charger's IP to other value and cannot remember, you can restore the charger to factory setting by long press the reset button. Then you can access it using http://192.168.1.5:8080

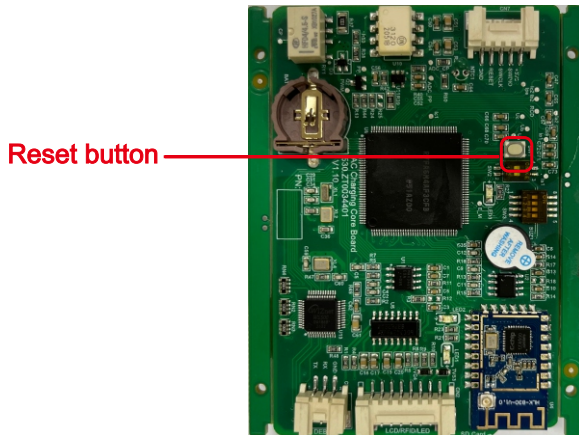

Please note: After restoring the charger to factory setting, you'll need to reset the charger ID and server url, otherwise the charger won't be connected to the back-office server.

12.5 Charging issue

If charging cannot start after the car is plugged in,

- a. Check if the red emergency stop button is pressed.
- b. Check what charge mode is being used

APP/RFID: Charge can only be started/stopped by APP or RFID card, and the charger must be connected to the back office server already;

RFID: Charge can only be started/stopped by RFID card;

Plug&Charge: Charge will start automatically when car is plugged in.

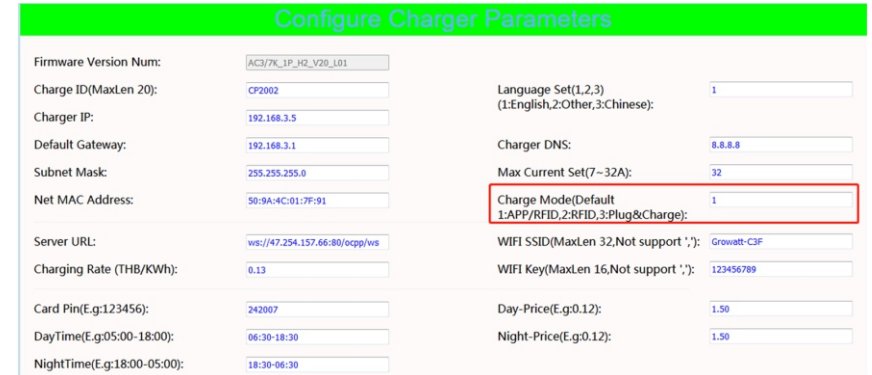

- c. Check if off-peak charging is set and if charger's time is correct.

If off-peak charging is set, charge can only start within the charging allowed time period.

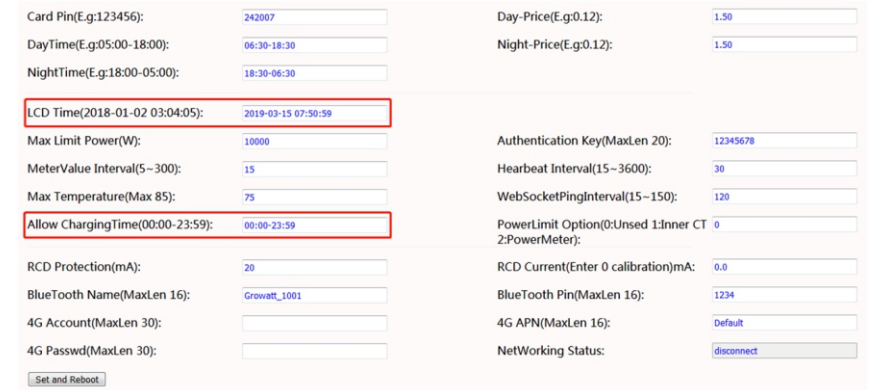

13. Specification

Model	THOR 07/09/12AS-P US
Dimension(mm)	9.68/15/6.06 in
Weight	< 9.5kg/20.9lbs
Display	LCD
Casing Material	Stainless steel& Engineering plastics& Tacyrylic
Input	
Voltage	AC 208/240V
Output	
Voltage	AC 208/240V
Max current	32/40/50A
Protection degree	NEMA Type 3R
Working environment temperature	-22°F~ 122°F
Relative humidity	5%~95%
Altitude	≤5000m (Derating begins above 3000 meters)
Frequency	60Hz
Communication	Ethernet/WIFI/4G
Charging mode	APP/RFID/Plug and charge
Standby power	<8W
Standard	UL2251 UL2594 UL2234-1/-2 FCC Part15
Mounting	Pole/Wall
Certificate	UL
Protection features	
Overvoltage	260V
Undervoltage	180V
Overcurrent	35.2/44/55A
Leakage protection	20mA CCID
Over temperature	Yes
Lightning protection	Type II

14. Annex

14.1 Warning and safety marks Label description

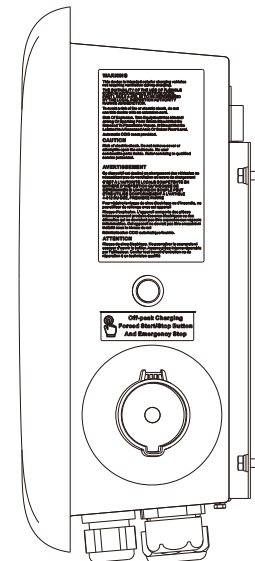

WARNING

This device is intended only for charging vehicles not requiring ventilation during charging.

THE SUITABILITY OF THE USE OF FLEXIBLE CORD IN ACCORDANCE WITH CE CODE, PART I, RULE 4-012, IS TO BE DETERMINED BY THE LOCAL INSPECTION AUTHORITY HAVING JURISDICTION.

To avoid a risk of fire or electric shock, do not use this device with an extension cord.

Risk Of Explosion. This Equipment Has Internal Arcing Or Sparking Parts Which Should Not Be Exposed To Flammable Vapors. It Should Not Be Located In A Recessed Area Or Below Floor Level.

Automatic CCID reset provided.

CAUTION

Risk of electric shock. Do not remove cover or attempt to open the enclosure. No user serviceable parts inside. Refer servicing to qualified service personnel.

AVERTISSEMENT

Ce dispositif est destiné au chargement des véhicules ne nécessitant pas de ventilation au cours du chargement C'EST À L'AUTORITÉ LOCALE COMPÉTENTE EN MATIÈRE D'INSPECTION QU'INCOMBE DE DÉTERMINER SI UN CORDON SOUPLE PEUT ÊTRE UTILISÉ CONFORMÉMENT À L'ARTICLE 4-012 DU CCÉ, PREMIÈRE PARTIE

Pour réduire le risque de choc électrique ou d'incendie, ne pas utiliser de rallonge avec cet appareil

Risque d'explosion. L'appareil comporte des pièces internes pouvant produire des arcs électriques ou des étincelles qui ne devraient pas être exposées aux vapeurs inflammables. Cet appareil ne devrait pas être encastré ni installé sous le niveau du sol

Réinitialisation CCID automatique fournie.

ATTENTION

Risque de choc électrique. Ne pas retirer le couvercle ni essayer d'ouvrir le boîtier. Aucune pièce interne réparable par l'utilisateur. Confier tout travail d'entretien ou de réparation à un technicien qualifié

14.2 Electrical diagram

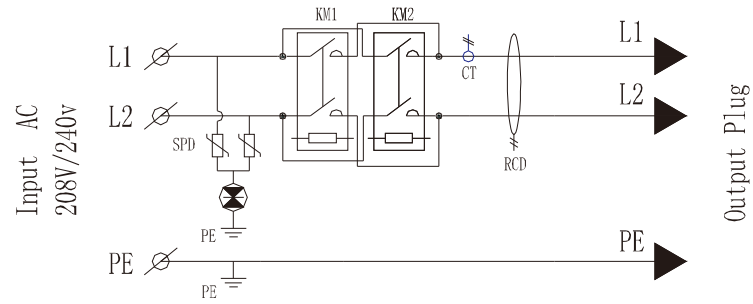

Fig14-1. Main circuit diagram

14.3 Contact

Company Name: Shenzhen Growatt new energy Co., Ltd

Address: 4-13F, Building A, Sino-German(Europe) Industrial Park, Hangcheng Ave, Bao'an District, Shenzhen, China

Website: www.ginverter.com

Service line: +86 755 2998 8492

E-mail: info@ginverter.com