



APX 86~200H-S1 High Voltage Battery System
User Manual

About This Document

This document introduces the APX 86~200H-S1 High Voltage Battery System (APX for short) in terms of its installation, electrical connection, operation, commission, maintenance, and troubleshooting. Before installing and operating the APX system, ensure that you are familiar with the product features, functions, and safety precautions provided in this document.

Symbol	Description
 WARNING	Indicates a potentially hazardous situation, if not avoided, could result in serious injury or death.

Table of Contents

1 Product Overview	1
1.1 Intended Use.....	1
1.2 Appearance.....	1
1.2.1 APX 1000140-C1 (Control Module)	1
1.2.2 APX 14.3P-B1 (Battery Module).....	4
1.3 Working Principle and Function	5
2 Safety	6
2.1 General Safety.....	6
2.2 Safety Precautions.....	6
2.2.1 Environmental Requirements.....	6
2.2.2 Operation Precautions.....	7
2.3 Label Description.....	7
2.4 Emergency Responses.....	9
3 Storage and Transportation	10
3.1 Storage Requirements.....	10
3.2 Transportation Requirements.....	10
4 Installation & Cable Connection	11
4.1 Basic Installation Requirements	11
4.2 Installation Tools.....	13
4.3 Installation Procedures	14
4.3.1 Pre-installation Check.....	14
4.3.2 Floor-mounted Installation	16
4.4 Electrical Connection.....	19
4.4.1 System Connection	19
5 Powering on/off the Battery System	29
5.1 Powering on the Battery System	29
5.2 Powering off the Battery System.....	30
6 Maintenance	31
6.1 Preparation	31
6.2 Replacing the BM or the CM.....	31
6.3 LED Indicators	31
6.4 Troubleshooting.....	32
7 Technical Specifications.....	34
7.1 APX 1000140-C1 (Control Module)	34
7.2 APX 14.3P-B1 (Battery Module)	34

1 Product Overview

1.1 Intended Use

The APX 86~200H-S1 High-voltage Battery System can supply power to loads working with WIT 28-55kW or WIT 50-100kW Hybrid Inverter when needed. Make sure to purchase the suitable Hybrid Inverter. If 6-8 battery modules are configured, please select the WIT 28-55kW model. If 9-14 battery modules are installed, please choose the WIT 50-100kW model.

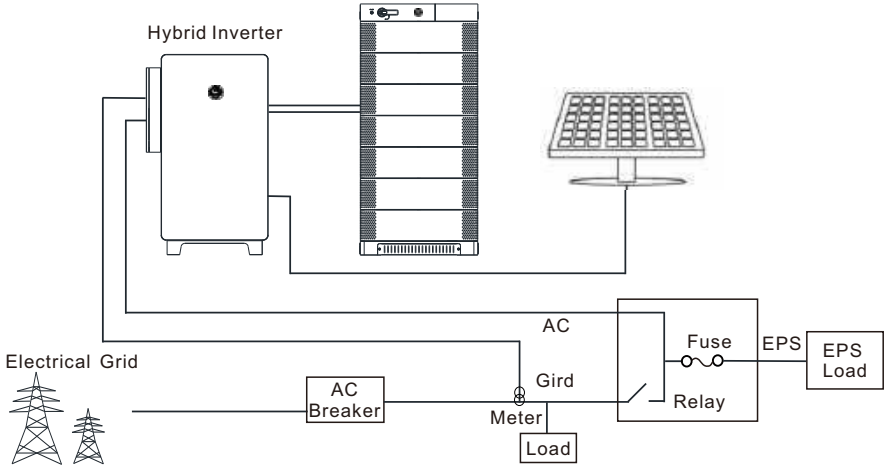

Figure 1-1: System diagram of the APX High Voltage Battery System

1.2 Appearance

1.2.1 APX 1000140-C1 (Control Module)

The APX 1000140-C1 Control Module (CM) consists of the power control unit, relay, fuse, DC switch, power and communication terminals. The appearance of the Control Module is shown below.

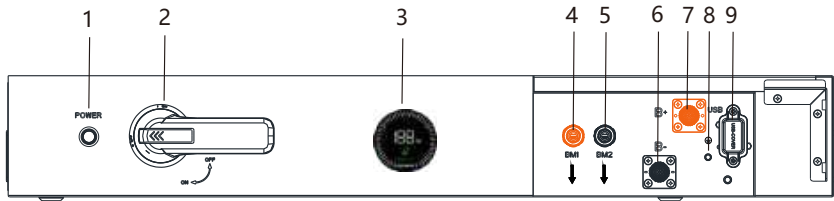

Figure 1-2: Front view of the APX 1000140-C1

NO.	Designation	Description
1	POWER	Power button
2	Switch	DC switch
3	LED	Battery operation indicator
4	BM1	BM & CM communication terminal 1
5	BM2	BM & CM communication terminal 2
6	BAT-	BAT negative terminal
7	BAT+	BAT positive terminal
8		Ground terminal, connected to the Battery Module
9	USB	Fault logging and firmware upgrade



Figure 1-3:Rear view of the APX 1000140-C 1

NO.	Designation	Description
1	Ventilation valve	Exhaust air and keep water out
2	PCS+	CM positive terminal, connected to hybrid inverter's positive terminal
3	PCS-	CM negative terminal, connected to hybrid inverte's negative terminal
4	SEM	Communication terminal, connected to the ShineMaster
5	AC INPUT	AC input terminal
6	PCS	Communication terminal, connected to the hybrid inverter

Dimensions (unit: mm)

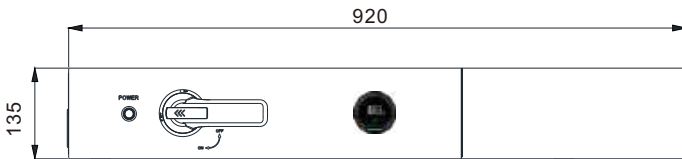

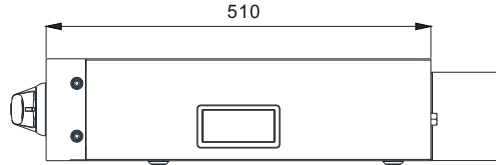

Figure 1-4: Dimensions of the APX 1000140-C1

LED display

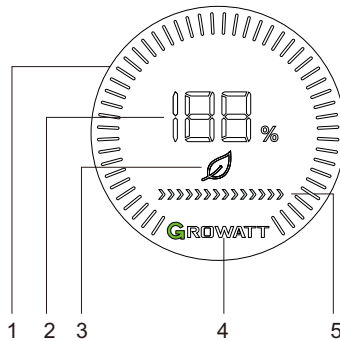

Figure 1- 5: LED display

No.	Function	Function description
1	Display SOC	Display current SOC in a circle progress bar
	Display the BM charge/discharge state & the system upgrade state	Light bars light up one by one clockwise during charging; Light bars go out one by one anticlockwise during discharging (the number of light bars corresponds to the system SOC with each representing 2% SOC). 8 light bars rotate clockwise during upgrading.
2	Display SOC	Display SOC in percentage
	Display the system upgrade state	"UP" is displayed when upgrading the program; "SU" is displayed when the program upgrade succeeds; "FA" is displayed when the program upgrade fails.
3	Display CM status	Steady green during normal operation; Blinking green indicates an alarm; Blinking red when a fault occurs.
4	Logo	The light is steady on when the APX system is powered on
5	Display BM status	Steady green during normal operation; Blinking green indicates an alarm; Steady red when a fault occurs.

1.2.2 APX 14.3P-B1 (Battery Module)

The APX 14.3P-B1 Battery Module (BM) consists of battery cells, DC-DC converter, mechanical parts, Battery Management Unit (BMU) as well as power and communication terminals. The appearance of the product is shown below.

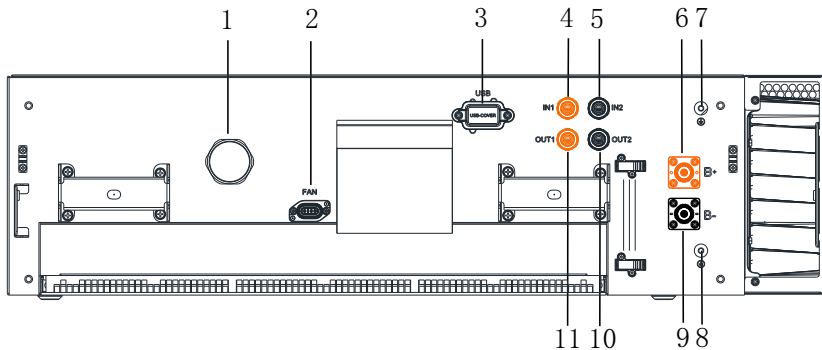



Figure 1-6: Appearance of the APX 14.3P-B1

NO.	Designation	Description
1	Explosion-proof valve	Exhaust air and keep water out
2	FAN	Fan power supply terminal
3	USB	Fault logging and firmware upgrade
4	IN1	Communication input 1, connected to OUT1 on the previous BM, or BM1 on the CM (for the first BM)
5	IN2	Communication input 2, connected to OUT2 on the previous BM, or BM2 on the CM (for the first BM)
6	B+	BAT positive terminal
7		Ground terminal, connect to the next module
8		Ground terminal, connect to the pervious module
9	B-	BAT negative terminal
10	OUT2	Communication output 2, connected to IN2 on the next BM, or covered with the short-circuit connector cap (for the last BM)
11	OUT1	Communication output 1, connected to IN1 on the next BM, or covered with the dust-proof cover (for the last BM)

Dimensions (unit: mm)

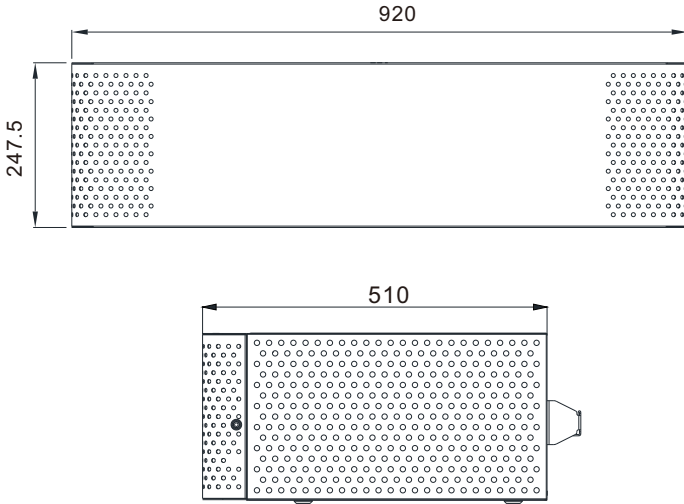

Figure 1-7: Dimensions of the APX 14.3P-B1

1.3 Working Principle and Function

The APX 86~200H-S1 High Voltage Battery System comprises a high voltage controller (APX 1000140-C 1) and multiple battery modules (APX 14.3 -B1) connected in series, including the electrochemical batteries, the battery control unit, the battery management unit, power and communication terminals and other mechanical parts. Compared with other energy storage systems, the APX system outperforms with superior charging and discharging performance, higher efficiency, flexible capacity expansion, precise monitoring, an extended cycle life and less self-discharge losses. A single APX system supports the connection of 6-14 battery modules in series, increasing the capacity and maximum charge/discharge power of the battery system. The APX battery system communicates with the hybrid inverter via CAN communication.

- Monitoring: monitor the voltage, current and temperature of both cells and the entire battery system.
- Protection and Alarm: initiate protection and generate alarms when overvoltage, undervoltage, overcurrent, over-temperature or under-temperature occurs.
- Report: report all alarms and status data to the hybrid inverter.
- Series connection: support the series connection of six to fourteen Battery Modules.
- Battery cell balancing: passive battery cell balancing.
- Battery module balancing: intelligent power distribution, active battery balancing.
- System off due to a fault: 6 minutes after the battery system and hybrid inverter communication is disconnected or after the under-voltage protection.

Safety 2

When installing or operating the battery system, the safety information contained in this section must always be followed. For safety reasons, it is the installer's responsibility to get familiar with this manual and all warnings before installation.

2.1 General safety

The product has been designed and tested in accordance with international safety requirements. As with all electrical or electronic devices, there are residual risks despite careful construction. Before installing or using the battery system, please read the instructions carefully and observe the all safety precautions at all time.

Growatt shall not be liable for any consequence of the following circumstances:

- Damage during the transportation by the customer.
- Damage caused by improper operations of a third part or customer, including those in transportation, storage, installation and use of the product.
- Improper installation by unprofessional and uncertified personnel.
- Failure to follow the operation instructions and safety precautions provided in this document.
- Unauthorized modifications or removal of the software package.
- The product's tamper evident label is removed or any item is missing due to customer's negligence or intentional damage.
- Operating the equipment in environments that cannot meet the requirements specified in this document.
- Damage caused by repairing, disassembling, and modifying the product without authorization.
- Tampering with labels on the chassis or modifying the date of production.
- Battery modules are left uncharged for more than six months.
- Damage due to force majeure, such as lightning, earthquakes, fire, and storms.
- Warranty expiration.

2.2 Safety Precautions









2.2.1 Environment Requirements



- The ambient temperature should not exceed 50°C and keep the battery away from heat sources.
- Do not install or use the battery in a wet place with moisture or liquids, such as in the bathroom.
- Do not expose the battery to corrosive gases.
- Do not place the battery in direct sunlight for extended periods of time.
- Battery power terminals shall not come in contact with conductive objects such as wires.
- Place the battery in a safe place and ensure that the battery is not accessible to children and animals.
- Do not dispose the batteries in fire, which may cause an explosion.
- Do not put the battery in contact with liquids.
- Do not place the battery against the wall. Instead, keep a clearance of at least 300 mm.



2.2.2 Operation Precautions

- Do not touch the battery system with wet hands.
- It is strictly prohibited to disassemble the battery system without authorization.
- Do not crush, drop or pierce the battery pack and the high voltage controller.
- The batteries must be disposed of in accordance with local safety regulations.
- When storing and recharging the battery, the instructions specified in this manual must be observed.
- Ensure reliable grounding.
- Remove all metal objects such as watches and rings that could cause a short circuit before installation, replacement and maintenance.
- Only qualified and well-trained personnel are permitted to repair, replace or maintain the battery.
- When storing or handling the battery, do not stack batteries without package.
- Handle the battery with caution to avoid leakage. The leaked electrolyte is toxic and hazardous to skin and eyes.
- Stack battery packing cases in compliance with the stacking requirements on the external package,
- Do not use damaged, faulty or deformed batteries, which may release flammable gases that may cause a fire or other safety hazards.

2.3 Label Description

Symbols	Description
	Do not dispose of the product together with the household waste but in accordance with the disposal regulations for electronic waste applicable at the installation site.
	Lithium-ion batteries can be recycled.
	CE marking This product complies with the requirements of the applicable EU directives.
	Be aware of electric shock.
	Be aware of explosive gas.
	Be aware of battery leakage.
	Heavy objects. Lift with care.
	Keep the battery pack away from children.

Symbols	Description
	Ensure that the positive and negative terminals are correctly connected.
	Keep away from open flames or other ignition sources.
	Observe the manual.

 APX High Voltage Battery System	
System Model/ Nominal Voltage/ Nominal Power/ Nominal Energy/ Rated Energy/	<input type="checkbox"/> APX 86.0H-S1/512 d.c.V /43kW/86.01kWh/77.41kWh <input type="checkbox"/> APX 100.3H-S1/512 d.c.V /50kW/100.35kWh/90.31kWh <input type="checkbox"/> APX 114.6H-S1/512 d.c.V /57kW/114.68kWh/103.21kWh <input type="checkbox"/> APX 129.0H-S1/768 d.c.V /64kW/129.02kWh/116.11kWh <input type="checkbox"/> APX 143.3H-S1/768 d.c.V /71kW/143.36kWh/129.02kWh <input type="checkbox"/> APX 157.6H-S1/768 d.c.V /78kW/157.69kWh/141.92kWh <input type="checkbox"/> APX 172.0H-S1/768 d.c.V /86kW/172.03kWh/154.82kWh <input type="checkbox"/> APX 186.3H-S1/768 d.c.V /93kW/186.36kWh/167.72kWh <input type="checkbox"/> APX 200.7H-S1/768 d.c.V /100kW/200.70kWh/180.63kWh
High Voltage Controller Model	APX 1000140-C1
AC Input	175-528 a.c.V, 50/60 Hz, 2.5 A
Operating Voltage Range	372-630 d.c.V(Nominal 512 d.c.V) 650-945 d.c.V(Nominal 768 d.c.V)
Max. Current	140 A
Peak Current	196 A,60 s
Protective Class	Class I
Ingress Protection	IP66
Operating Ambient Temperature	-10°C ~ +50°C
 x Made in China	



 Lithium Ion Battery	
Model	APX 14.3P-B1
Nominal Energy	14.33 kWh
Rated Energy	12.89 kWh
Output	0-105 d.c.V, 140 A 7.16 kW
Peak Output Current	196 A,60 s
Protective Class	Class I
Battery Interface	Non-Isolated
Ingress Protection	IP66
Weight	135 kg
Operation Ambient Temperature	-10°C ~ +50°C
 x Made in China	

Figure 2-1: Nameplate

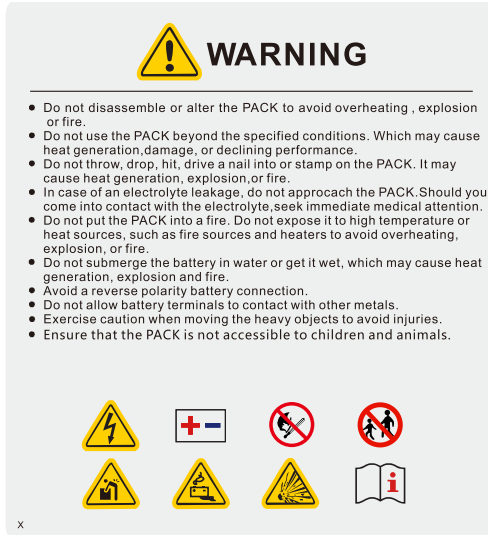



Figure 2-2: Label

 WARNING	Performance de-rate may be initiated when the temperature is below 0°C
---	--

2.4 Emergency Responses

Manufacturer takes foreseeable risk scenarios into consideration and the product has been designed to reduce hazards and dangers. However, if the following situation occurs, please do as below:

Emergency	Description and suggested measures
Leakage emergency	Avoid contact with leaked liquids or gases. Should you come into direct contact with the battery electrolyte, do as follows: <ul style="list-style-type: none"> ➤ Eye contact: flush your eyes with flowing water for 15 minutes, and seek immediate medical attention. ➤ Skin contact: wash the affected area with soap and water, and seek immediate medical attention. ➤ Ingestion: seek immediate medical attention
Fire emergency	Normally, the battery system won't ignite spontaneously. If a fire occurs, do not try to extinguish the fire but evacuate people immediately.
Flood emergency	If the battery system is soaked or submerged in water, do not touch the batteries to avoid electric shock. Contact Growatt or your distributor immediately for technical assistance.
Shell damage	The shell damage requires extra attention as it is of high risk. Do not use batteries with a damaged shell, which may cause safety hazards. Contact Growatt or your distributor to dispose of them.

Storage and Transportation 3

3.1 Storage Requirements

- Handle the batteries according to the signs on the packing case.
- Do not put batteries upside down or on their side.
- Do not store damaged batteries near undamaged ones.
- The storage environment requirements are as follows:
 - Install the batteries in a dry, clean and well-ventilated place.
 - Recommended storage temperature: -20°C to 50°C (storage period: one week); -20°C to 40°C (storage period: 6 months).
 - Relative humidity: 5% to 95% RH.
 - Do not expose batteries to corrosive environments.
 - Protect the batteries against direct sunlight and rain.
 - Keep the batteries at least two meters away from heat sources (such as a radiator).
 - Avoid exposure to intense infrared radiation.



Notice

If the battery pack is not used for more than six months, carry out a charging cycle every six months.

3.2 Transportation Requirements

This product has been certified to comply with UN38.3 (Section 38.3 of the sixth Revised Edition of the Recommendations on the Transport of Dangerous Goods: Manual of Tests and Criteria) and SN/T 0370.2-2009 (Part 2: Performance Test of the Rules for the Inspection of Packaging for Exporting Dangerous Goods). The battery pack belongs to Class 9 dangerous goods.

- The battery pack shall not be transported with other inflammable, explosive or toxic substances.
- Ensure that the original package and labels are intact and identifiable.
- Avoid direct exposure to sunlight, rain, condensing water caused by temperature difference and mechanical damages.
- Do not pile up more than four battery modules.
- There might be a drop in capacity during transportation and storage.
- Keep the transportation temperature between -20°C to 45°C and the relative humidity within the range of 5%~95%RH.

4 Installation & Cable Connection



WARNING

- Read through this manual before installation to get familiar with the product information and safety precautions.
- Only qualified and well-trained technicians who fully understand the whole photovoltaic system, grid network, battery system, working principle and national/local standards are allowed to perform operations on the battery system.
- Installers must use insulating tools and wear safety gear during operation.
- Device damage caused by failure to comply with the storage, transportation, installation or operation requirements specified in this document is not covered under any warranty.
- Do not install or use the battery near explosive or inflammable materials.
- Use the battery in a well-ventilated environment with temperature ranging from -10°C to 50°C . For outdoor installation, build a sun & rain shelter to avoid exposure to direct sunlight and rain.
- The batteries should be protected from dust and dirt. Do not expose batteries to high humidity.

4.1 Basic Installation Requirements

- The battery system can be installed indoors or outdoors. The angle and clearance requirements are shown below:

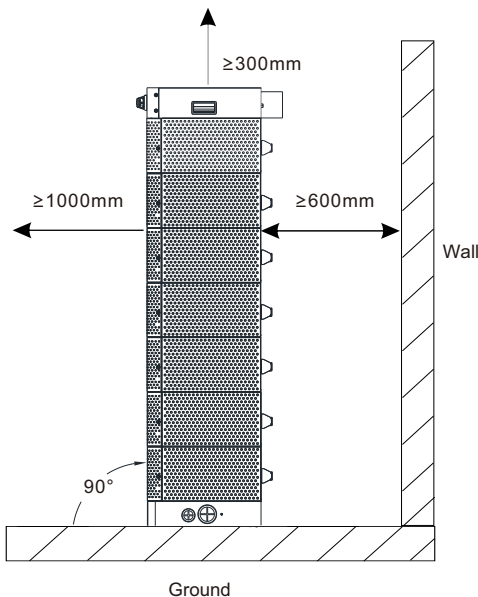

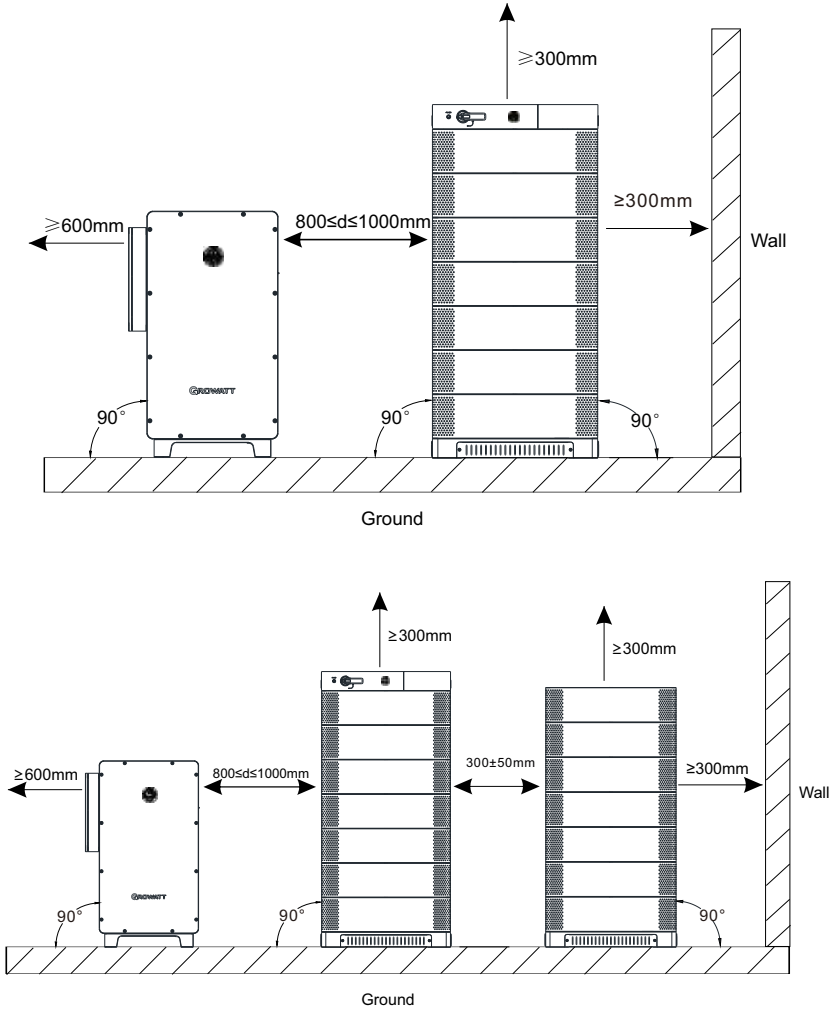

Figure 4-1: Floor-mounted installation

Note:

1. The system should be installed with the help of at least 2 grown-up males.
2. It is recommended to use a forklift during installation.
3. A maximum of 7 battery modules can be stacked in one column. If more than 7 of them are to be configured, please install them in two columns.



WARNING

Do not place the battery pack upside down.

- When installing the battery system outdoors, it is recommended to install a sun shelter over the system to avoid exposure to direct sunlight; otherwise, the battery system might fail to charge or discharge normally, or it might even damage the system.

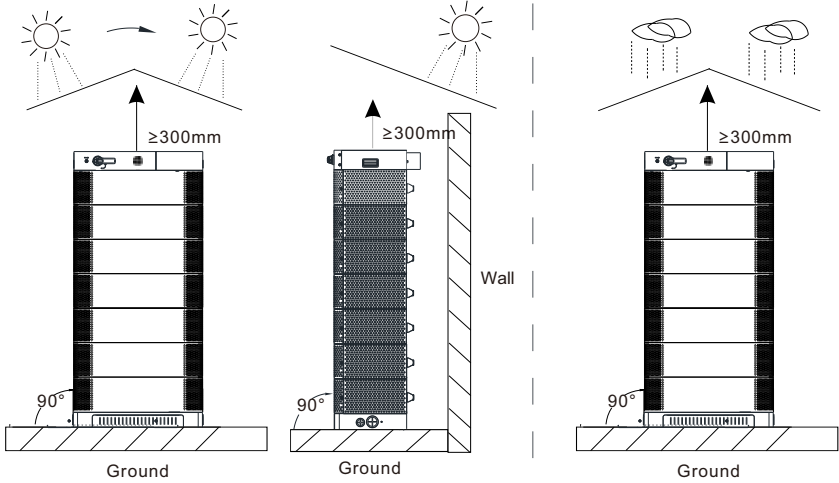
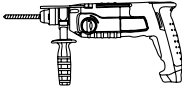
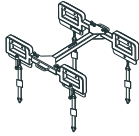



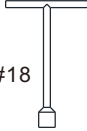

Figure 4-2: Installing a sun & rain shelter

4.2 Installation Tools

 Cross-head screwdriver (PH2)	 Allen key #5	 Socket wrench #8 #10
 Knife	 Marker	 Measuring tape
 Electric screwdriver (PH2, crosshead)	 Hammer	 Multimeter

		
Electric drill	Auxiliary tool	Forklift
		
Lifting platform	Crane	#18 T type socket wrench

It is recommended to wear the following safety gear when handling the battery system.

		
Insulated gloves	Safety goggles	Safety shoes

4.3 Installation Procedures

4.3.1 Pre-installation Check

- Check the package before unpacking it. If any damage is found, do not unpack the package and contact your distributor.
- Check the quantity of all components according to the package list. If any damage is found or any component is missing, please contact your distributor.

4.3.1.1 Check the components of the APX Battery System in different capacities



APX 1000140-C1(entire unit)

A

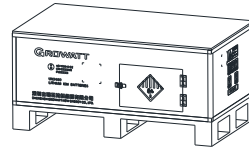

APX 14.3P-B1(entire unit)

B

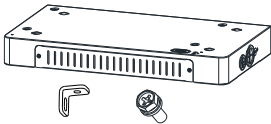

APX 14.3P-B1 Base & the connecting piece and the M6 screw to secure the base

C

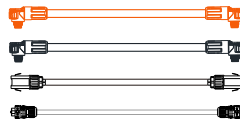

Cable set connecting the hybrid inverter with the CM

D

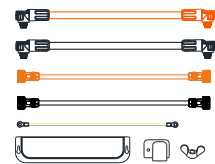

Cable set connecting two columns of batteries

E

Figure 4-3: Configuration of the APX Battery System in different capacities

Hybrid inverter model	Battery system capacity	Configuration
WIT 28-55kW	86.01kWh	A+B*6+C+D
	100.35kWh	A+B*7+C+D
	114.68kWh	A+B*8+C*2+D+E
WIT 50-100kW	129.02kWh	A+B*9+C*2+D+E
	143.36kWh	A+B*10+C*2+D+E
	157.69kWh	A+B*11+C*2+D+E
	172.3kWh	A+B*12+C*2+D+E
	186.36kWh	A+B*13+C*2+D+E
	200.70kWh	A+B*14+C*2+D+E

4.3.1.2 Check the package of the Control Module

The Control Module model for the APX High Voltage Battery System is APX 1000140-C1.

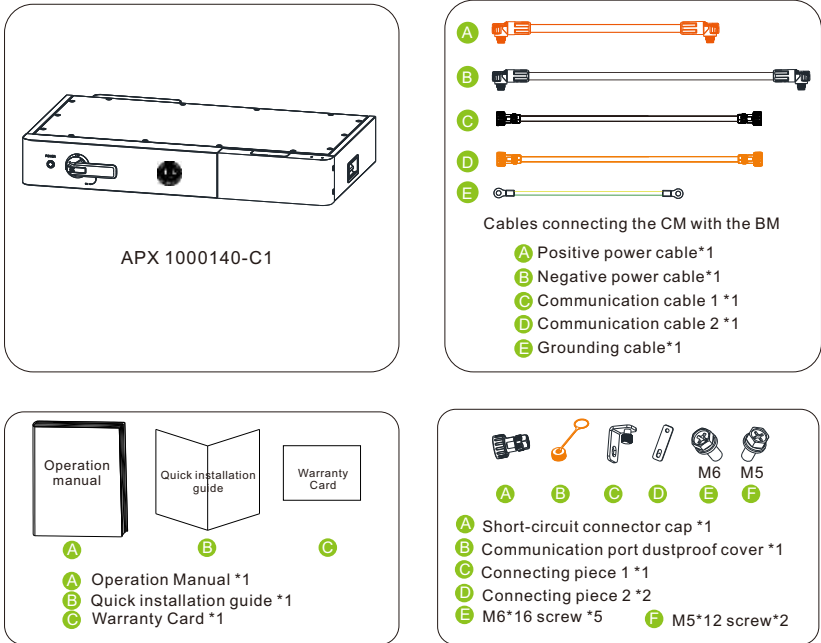

Figure 4-4: Components included in the package of the Control Module

4.3.1.3 Check the package of the Battery Module

The Battery Module model used in the APX High Voltage Battery System is APX 14.3P-B1. A minimum of 6 battery modules should be used in one system while the maximum limit is 14.

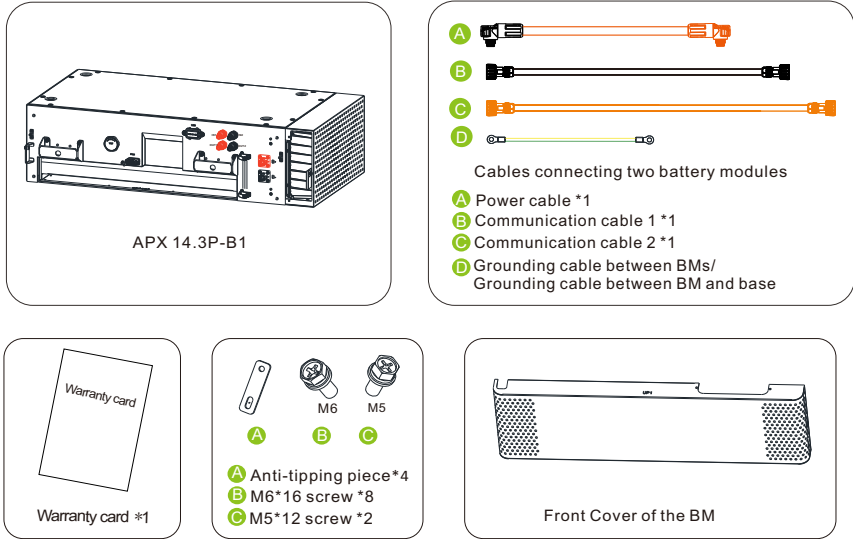



Figure 4-5: Components included in the package of the Battery Module

 Notice	<ul style="list-style-type: none"> ➤ The Control Module and the Battery Module are indispensable components for building the APX High Voltage Battery System. Please select an appropriate number of the components based on your needs. In one APX Battery System, only one Control Module is required and 6-14 Battery Modules can be configured. ➤ The base is a standard accessory as the battery cannot be placed on the floor directly. During installation, please install the base first.
---	---

4.3.2 Floor-mounted Installation

Note:

1. A maximum of 7 battery modules can be stacked. If more than 7 battery modules are to be installed, you are advised to install them in two columns.
2. One battery column (seven BMs + one CM) is about 2000 mm in height. Please maintain a clearance of 300mm above the CM. Namely, ensure that the distance between the floor and the ceiling is greater than 2300 mm for the convenience of installation and better heat dissipation.
3. The system should be installed with the help of at least 2 grown-up males.
4. It is recommended to use a forklift during installation.
5. If the use of a conduit is required, please install the bushing to the reserved hole before installing the expansion screw.

Step 1: Install the battery base:

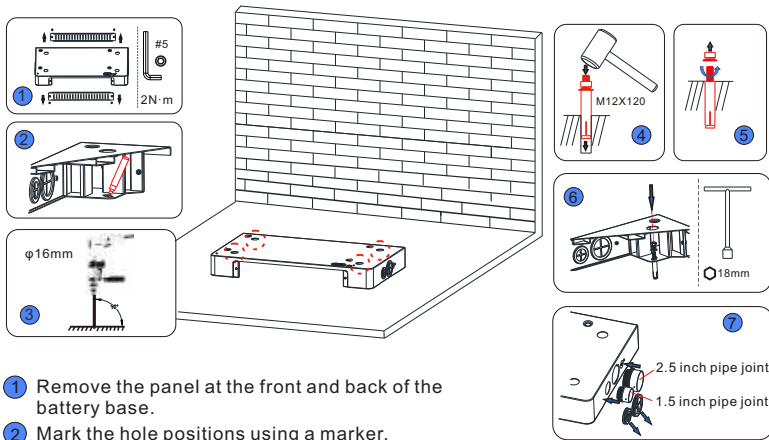

- 1 Remove the panel at the front and back of the battery base.
- 2 Mark the hole positions using a marker.
- 3 Drill holes at the marked positions to a depth of 95 mm.
- 4 Knock the expansion screws into the holes (M12×120).
- 5 Remove the flat washer, the spring washer and the nut.
- 6 Place the base on the selected position, then install the flat washer, the spring washer and the nut. Tighten the nut to secure the base.
- 7 When installing in two columns, you need to remove the rubber sealing plugs on the side of the base and install the conduit fittings with appropriate specifications. Determine the length of the conduit according to the distance between two columns and install the conduit.

Figure 4-6: Installing the battery base

Step 2: Move the auxiliary tool onto the forks of the forklift.

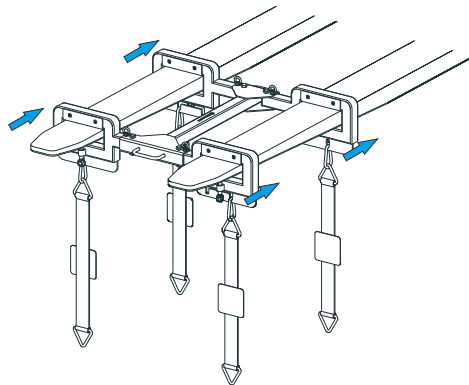

Figure 4-7: Moving the auxiliary tool

Step 3: Place the Battery Module onto the base, ensuring that the locating pins of the BM align with the locating points on the base.

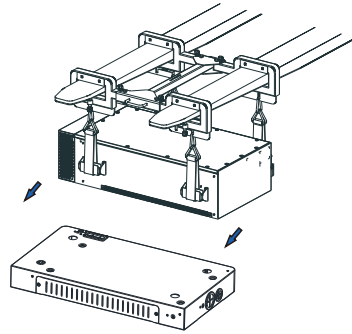

Figure 4-8: Placing the battery module

Step 4: Install the 4 anti-tip connecting pieces between the BM and the base to avoid tip-overs during installation.

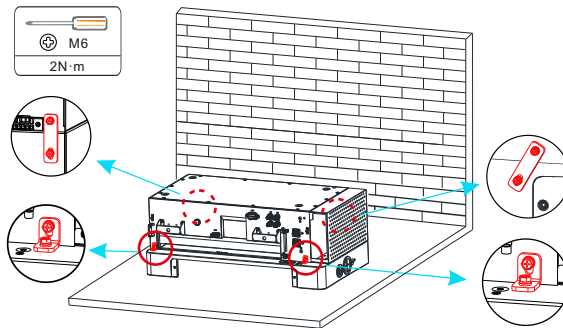

Figure 4-9: Connecting the anti-tip connecting pieces between the BM and the base

Step 5: Connect the 4 anti-tip connecting pieces between two BMs. It is not recommended to install the anti-tip pieces after stacking all the BMs as it might cause an accident due to the falling BM.

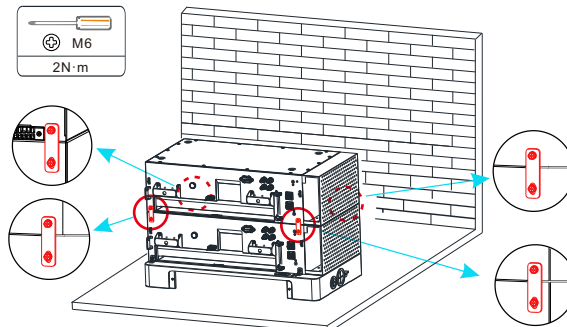

Figure 4-10: Connecting the anti-tip components between two BMs

Step 6: Connect the 4 anti-tip connecting pieces between the BM and the CM. Therefore, it is necessary to install the anti-tip components properly.

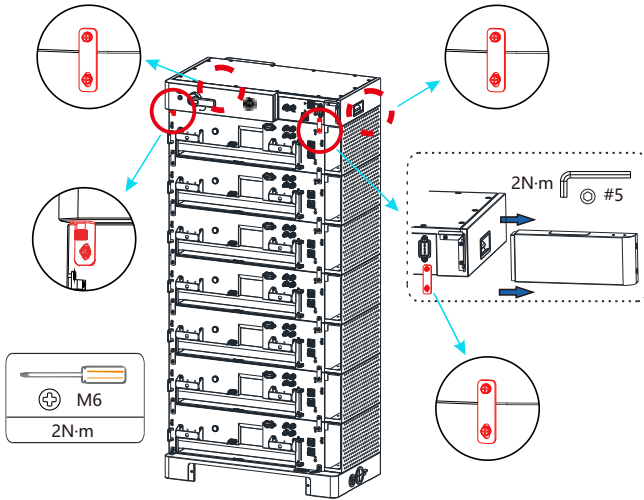



Figure 4-11: Connecting the anti-tip components between the BM and the CM

Note: Remove the front cover of the CM before installing the connecting pieces.

 Notice	<ul style="list-style-type: none"> ➤ A maximum of 7 battery modules can be stacked in one column (excluding the control module). ➤ Keep a clearance of at least 300mm around the battery and do not place them against the wall.
--	--

4.4 Electrical Connection

 WARNING	<p>Do not forget to wear the ESD wrist strap, safety gloves and goggles.</p>
---	--

4.4.1 System Connection

 Notice	<p>A circuit breaker is integrated in the Control Module. Therefore, it is not recommended to install a DC circuit breaker between the battery system and the hybrid inverter. If the use of a DC circuit breaker is required, do not operate the DC breaker with power on; otherwise, it may cause damage to the equipment. Please ensure that the specifications of the DC breaker meet the following requirements:</p> <ol style="list-style-type: none"> a. Voltage: 1000 Vdc b. Current: 300A
--	--

4.4.1.1 Battery Capacity Description

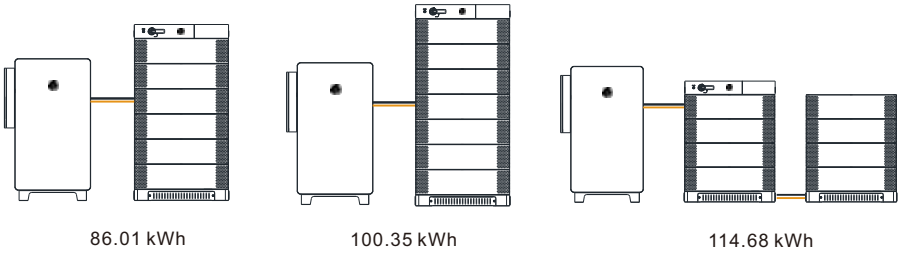

Figure 4-12: Installation diagram of the battery system with a capacity of 86.01kWh to 114.68kWh

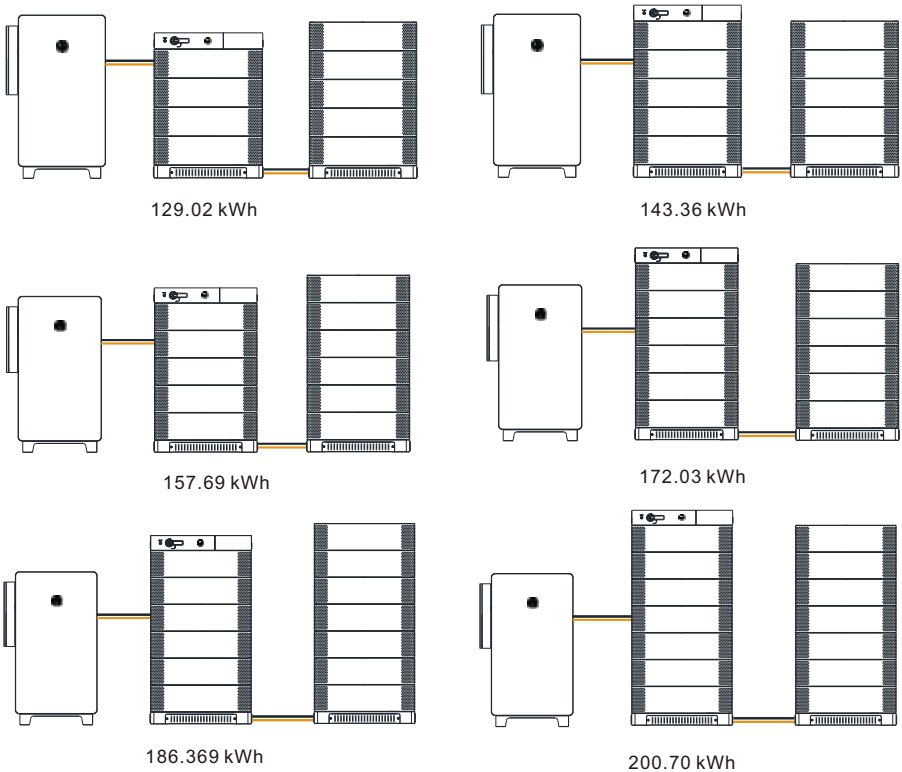

Figure 4-13: Installation diagram of the battery system with a capacity of 129.02 kWh to 200.7 kWh

Note:

When configuring the Battery Modules in two columns, please purchase two bases and the extension cables for series connection, which include the power cable, the communication cable and the PE cable.

4.4.1.2 CM and BM Wiring

A. APX 1000140-C1 (Control Module) wiring

Step 1: Plug the power cables into the corresponding ports. The “Click” sound indicates a secure connection has been made. The power cables can be found in the package of the Control Module.

Step 2: Connect the communication cables to the BM1, BM2, and PCS ports accordingly, and tighten the communication terminals clockwise. The PCS communication port is used to communicate with the hybrid inverter. The BM1 and BM2 communication ports are used to communicate with the battery modules, which are connected to the IN1 and IN2 ports of the battery module. The communication cables can be found in the package of the Control Module.

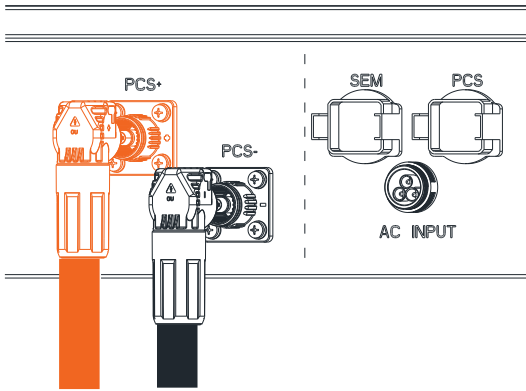

Figure 4-14: Connecting the power cables between CM and hybrid inverter

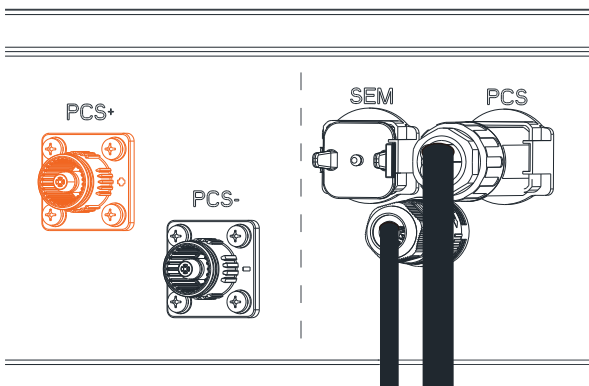

Figure 4-15: Connecting the communication cables and the AC input cable between CM and hybrid inverter

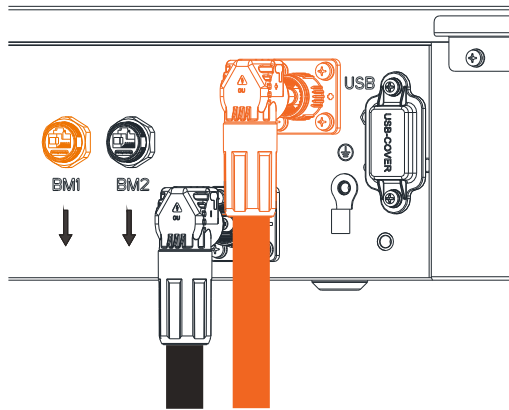

Figure 4-16: Connecting the power cables between CM and BM

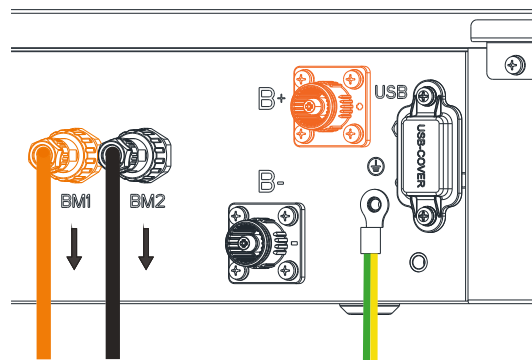

Figure 4-17: Connecting the communication cables between CM and BM



Notice

- Please pay attention to the color of the connectors when connecting power cables. Only connectors with the same color can be connected.
- For safe operation of the system, it is necessary to ensure reliable grounding.
- This area is a restricted access area, which is explained as follows:
 - Area accessible only to electrically skilled persons and electrically instructed persons with proper authorization.
 - Note 1 to entry: An electrically skilled person is a person with relevant education and experience to enable him or her to perceive risks and to avoid hazards electricity can create.
 - Note 2 to entry: An electrically instructed person is a person adequately advised or supervised by electrically skilled persons to enable him or her to perceive risks and to avoid hazards which electricity can create.

B. APX 14.3P-B1 (Battery Module) wiring

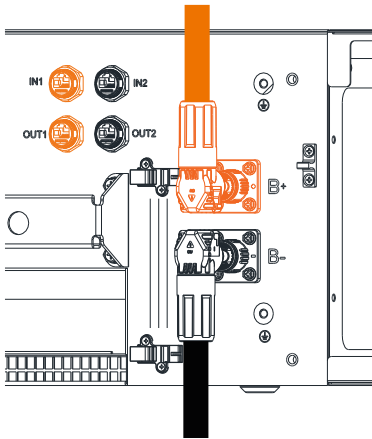

Figure 4-18: Connecting the power cables between BMs

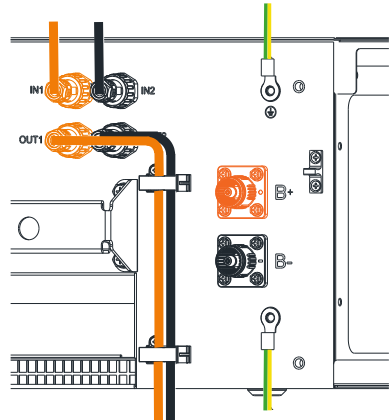

Figure 4-19: Connecting the communication cables between BMs

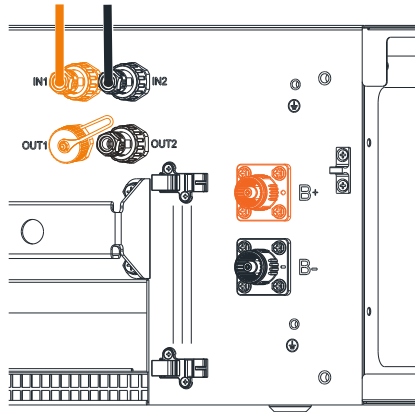

Figure 4-20: Installing the dust-proof cover and the short-circuit connector cap on the last BM

- Step 1:** Insert the power cable into the corresponding port until you hear a “Click” sound, which indicates a secure connection.
- Step 2:** Connect one end of Communication cable 1 to the IN1 port and the other end to the OUT1 port on the next battery module. Then connect one end of Communication cable 2 to the IN2 port and the other end to the OUT2 port on the next battery module. Secure the communication terminals in place by tightening them clockwise.
- Step 3:** For the last BM, please install the dust-proof cover to the OUT1 port and the short-circuit connector cap to the OUT2 port.



Notice

- The last battery module refers to the one furthest from the Control Module.
- Please pay attention to the color of the connectors when connecting power cables. Only connectors with the same color can be connected.

4.4.1.3 System wiring and installing the covers

Step1: Cut the rubber sealing plug on the base with a knife before connecting cables.

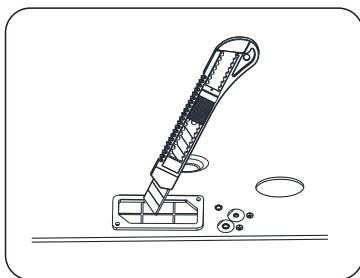
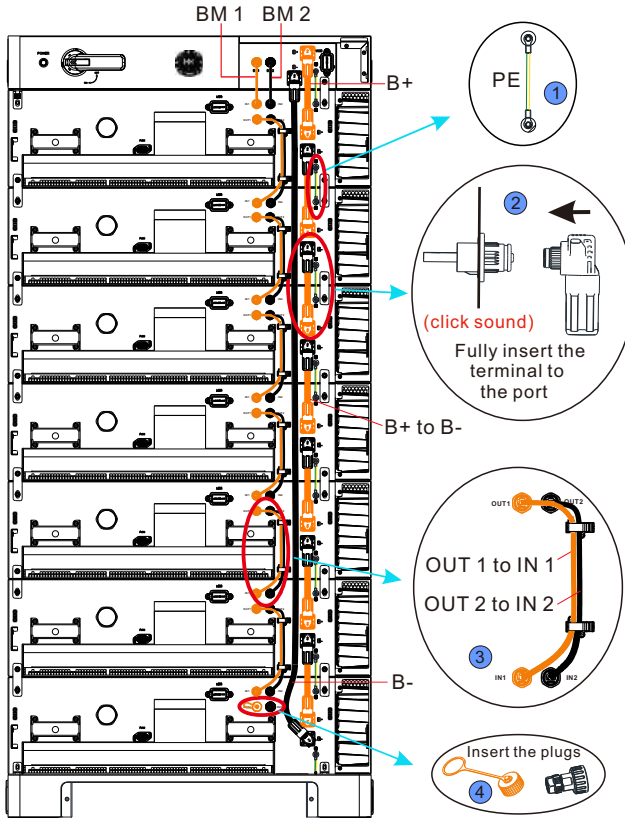

Figure 4-21

NOTE

1. If less than seven battery modules are installed, you can skip this step.
2. Prior to connecting cables, please cut the rubber sealing plug on the base using a knife.
3. Alternatively, you can cut the rubber sealing plugs on the sides of the base or remove them, which is not recommended as it might compromise the sealing performance of the system. If the use of a conduit is required, please remove the plugs and install the conduit fittings. The conduit and fittings should be separately purchased.
4. You are advised to route all the cables through the holes before connecting them.

Step 2: Connect external cables of the battery system.



- ① Install the grounding cable first. (The grounding cable **MUST BE** connected first; otherwise it might interfere the installation of the power cables).
- ② Insert the power cable connector into the corresponding terminal until you hear a click sound.
- ③ Install communication cables. Connect OUT1 to IN1 on the next BM and OUT2 to IN2 on the next BM.
- ④ For the last battery, cover the OUT1 with the dust-proof cover and the OUT2 with the short-circuit connector cap.

Figure 4-22: Cable connections of a single column

NOTE:

1. Verify that the voltage at the battery output terminal is 0V using a multimeter to avoid connecting cables with power on.
2. Connect cables following the sequence demonstrated in the figure. The communication cables are installed lastly. Avoid mistakenly powering on the machine during installation.
3. Once the power cables are installed, you can pull the cables slightly to ensure that they are securely connected.

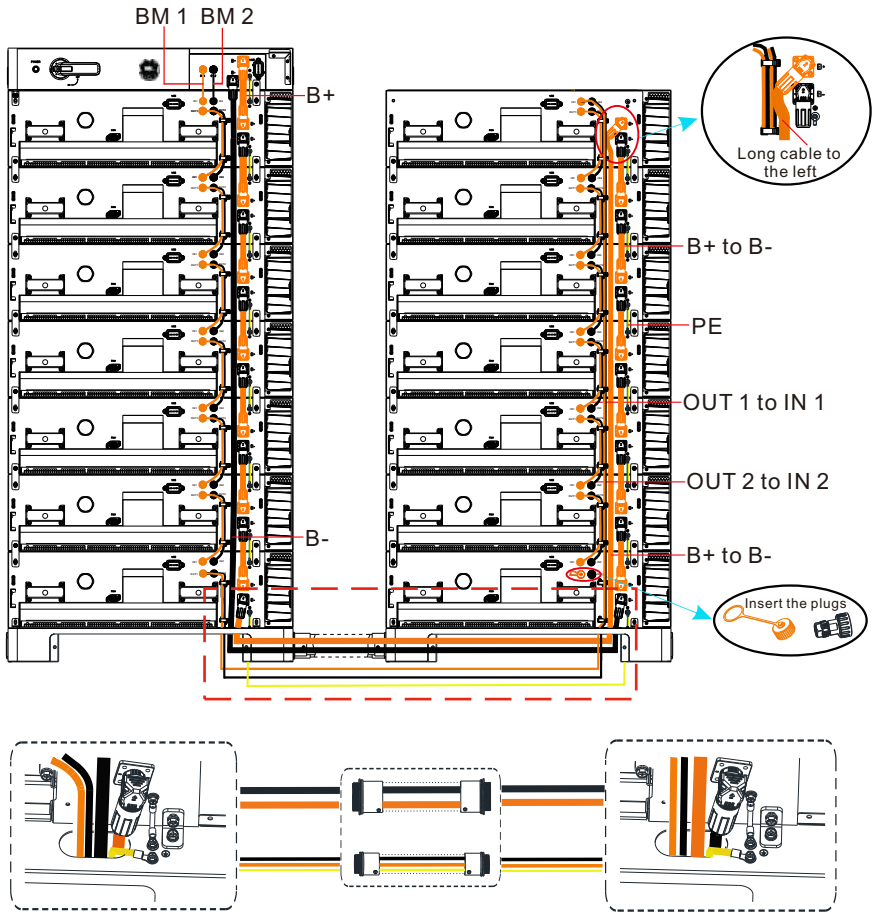

Figure 4-23: Cable connections between two columns

NOTE:

1. When connecting the power cables and communication cables between the two columns, make sure to pass the wires through the two wire holes on the base before connecting them to the other column. (The length of the wires for connection between two columns is designed based on the situation where a maximum of 7 battery modules are installed in the second row. If the wires are too long for the actual use, please place the excess part into the middle of the base through the cable routing hole.)
2. Connect the power cables and the communication cables from the bottom BM in the column with the CM to the top BM of the other column. Ensure that the dust-proof cover and the short-circuit connector cap are in place on the OUT1 and OUT2 terminals of the BM farthest from the CM.
3. Connect the B- terminal of the BM farthest from the CM to the B- terminal of CM.
4. The cable color is for demonstration purpose only. The actual cable color prevails.

Step 3: Connect external cables between the CM and the hybrid inverter.

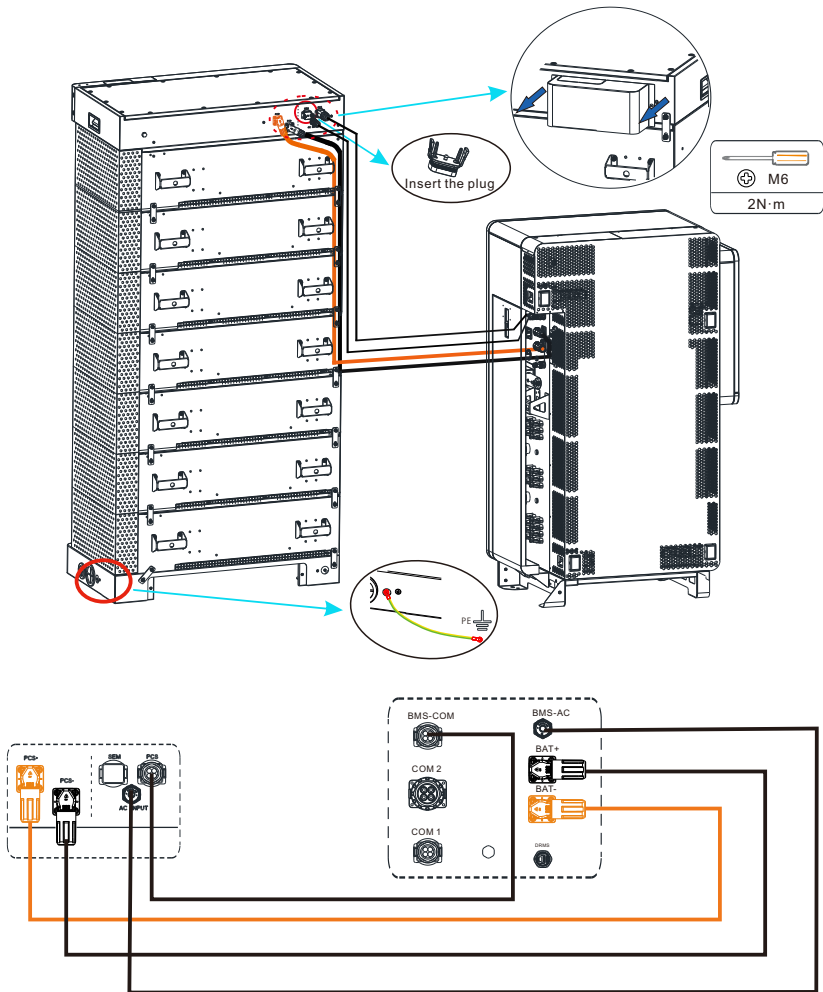

Figure 4-24 Connecting the CM and the hybrid inverter

NOTE:

1. Remove the back cover of the CM.
2. Connect the power cables from the hybrid inverter to the PCS+ and PCS- terminals on the CM. Ensure the correct polarity when connecting cables.
3. Connect the PCS port on the CM to the BMS communication port on the hybrid inverter.
4. Install the dust-proof cover onto the SEM port of the CM.
5. Connect the grounding cable from the ground point on the base to the ground. The grounding cable **MUST BE** properly connected; otherwise, it may cause system damage or electric shocks. The ring terminals to be crimped with the grounding cable can be found in the cable package.

Step4: Reinstall the front and back panels of the base.

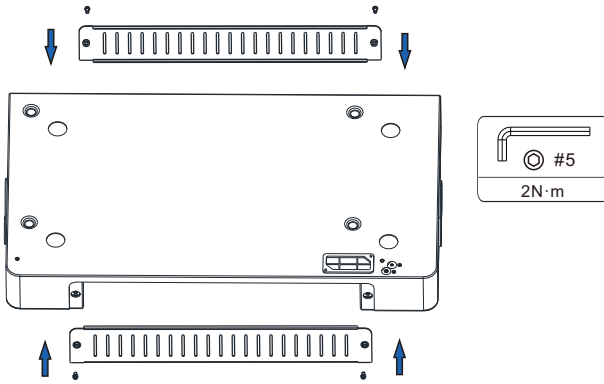
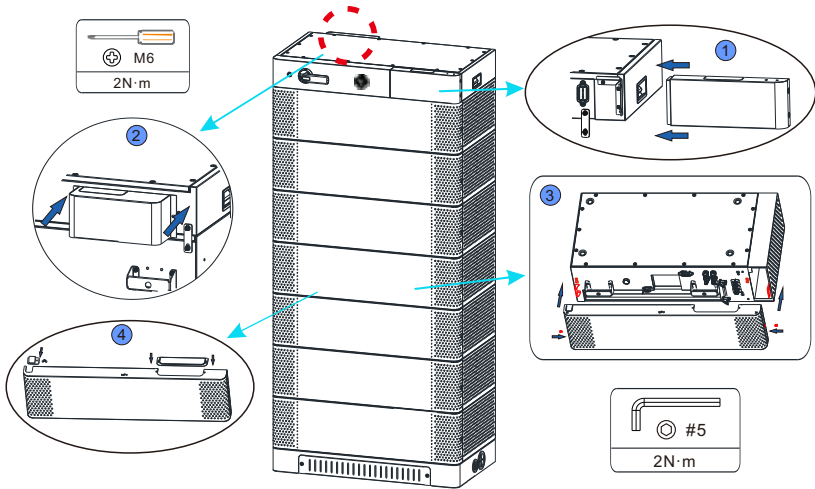

Figure 4-25 Installing the front and back panels

Step 5: Install the covers for the whole system.



- ① Slide the front cover onto the CM from the side and fasten the screws.
- ② Install the back cover of the CM.
- ③ Install the front cover of the BM and tighten the screws on both sides.

NOTE:

- ④ If the battery system is configured in two columns, prior to installing the front cover of the top BM in the second column, you need to install the two sealing plates as shown in the figure marked with ④.

Figure 4-26 Installing the covers for the whole system

5 Powering on/off the Battery System

 Notice	<ul style="list-style-type: none"> ➤ Personnel who install and operate the Battery System must receive thorough training and possess the local national required qualifications before operation. Only qualified professionals and trained personnel are allowed to install, operate and maintain the equipment. ➤ Please stand on dry, insulating objects and do not wear conductive material such as watches and necklace during operation. Insulated tools should be used. ➤ Avoid contact with any parts with electric potential difference. ➤ Hang the warning sign: Do not touch. Authorized personnel only. ➤ If any abnormality is found when the equipment is energized, turn off the DC switch immediately. After the fault is rectified, turn on the switch again. ➤ Make sure that the hybrid inverter is off before checking the APX battery system.
--	---

5.1 Powering on the Battery System

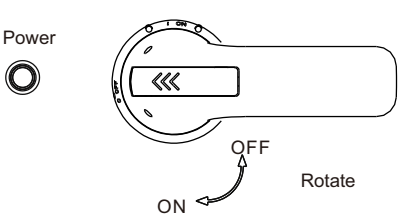
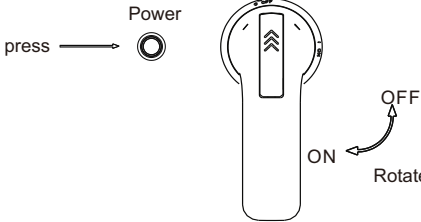
	
<p>Before turning on the battery, please check if all cables are properly connected. Turn the DC switch on the Control Module to the "ON" position, then press the power button for 1 to 2 seconds. The battery system will be powered on in about 2 seconds when you hear the sound of the fan in operation.</p>	

Turn the DC switch to ON , and then press the "Power" button (1s<t<2s)

No.	Procedure	Acceptance criteria
1	Connect the battery and the hybrid inverter	Make sure the wiring harnesses are securely connected
2	Set the DC switch to the ON position	Ensure that the DC switch is set to the ON position
3	Press the POWER button for 1 to 2 seconds. Observe the LED indication on the front panel	<ol style="list-style-type: none"> 1. If the LED display of the control module lights up in 10 seconds, the system is successfully powered on. 2. If the LED indicator turns red, a fault might have occurred. Please shut down the system and rectify the issue before restarting it.

5.2 Powering off the Battery System

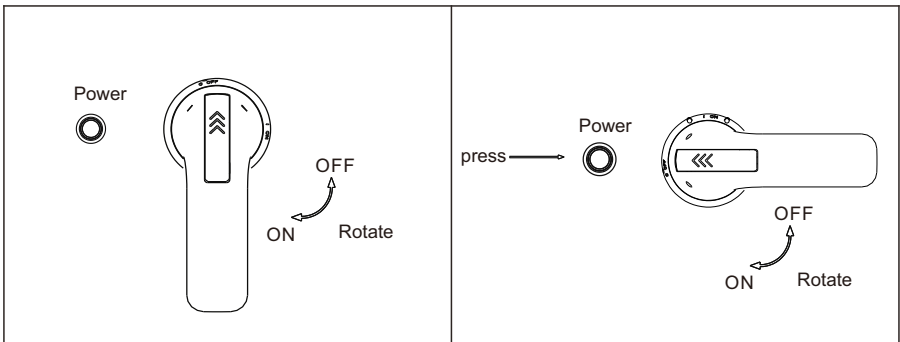

Serial	Procedure	Acceptance criteria
1	Press the POWER button for 10 to 15 seconds.	Press the "POWER" button for 10-15 seconds.
2	Set the DC switch to OFF	The DC switch is set to the "OFF" position.

6 Maintenance



6.1 Preparation

After the system is powered off, the remaining electricity and heat exist in the chassis, which may cause electric shocks or burns. Therefore, wait 10 minutes after the system is powered off and wear protective gloves during operation.

6.2 Replacing the BM or the CM

- Wear safety gloves.
- Turn the DC switch on the control module to OFF and long press the POWER button to power off the battery system.
- Disconnect power cables and CAN communication cables connected to the battery system.
- Remove the front cover and the anti-tipping connecting pieces on both sides. Remove the battery module or the control module using the auxiliary tool.
- Put the battery module or the control module into the packing box according to the repair procedure and transport the battery module or the control module to the designated repair site.
- Install a new unit following the procedure specified in Section 4.

6.3 LED indicators

			Meaning
Steady white	Blinking green at long intervals	Steady green	Standby mode
Blink in clockwise direction	Steady green	N/A	Charging mode
Blink in anti-clockwise direction	Steady green	N/A	Discharge mode
N/A	Blinking green at short intervals	N/A	Alarm
N/A	Steady red	N/A	System failure
N/A	Blinking red at long intervals	Steady red	Battery module failure
LED indicators blink clockwise and "UP" is displayed	N/A	N/A	Upgrade
Off	Off	Off	Hibernation mode
Blinking green at short intervals (on for 0.5s and then off for 0.5s or on for 0.5s and then off for 2s)			
Blinking green at long intervals (on for 0.5s and then off for 2s)			
Blinking red at long intervals (on for 1s and then off for 1s)			

x

6.4 Troubleshooting

Indicator	Description	Cause	Measures
ALM			
 (Red Light on) Control Module	Communication with hybrid inverter failed	Communication loss between hybrid inverter and the APX battery system	1. There is no safety risk. 2. Ensure that the hybrid inverter is powered on. 3. Check if the communication cables between the hybrid inverter and the battery system are securely connected. 4. If the problem persists, users should contact the installer to repair the battery.
	Communication with BM failed	Communication loss between the Control Module and the Battery Module	Check whether the communication cable between the Control Module and the Battery Module is securely connected.
	BUS short-circuited	Power cable short-circuited	Check whether the positive and negative terminals are reversely connected.
	Power cable connection failure	The power cable is disconnected from the hybrid inverter	1. Check whether the power cable between the Control Module and hybrid inverter is securely connected. 2. Check if the switch is turned to the position "ON". 3. Check the fuse.
	High temperature protection	The temperature exceeds the BMS protection value	Stop using the battery immediately. Wait until the battery cools down and the alarm will disappear.
	Low temperature protection	The temperature is below the protection value	No safety hazard. Wait for the temperature to rise and the alarm will disappear.

Technical Specifications 7

7.1 APX 1000140-C1 (Control Module)

No.	Items	Specifications
1	Model	APX 1000140-C1
2	BAT+/BAT- voltage range	250V-950V
3	PCS+/PCS- voltage range	250V-950V
4	Maximum current	140A
5	Peak current	196A
6	Temperature range	-10~50°C
7	IP rating	IP66
8	Warranty	≥ 10 years
9	Communication method	CAN
10	Dimensions (W/D/H)	920*510*135 mm ±2mm
11	Weight	25±1kg
12	Certification & Licensing	IEC62040/IEC62477/IEC62619/CE /RCM/VDE2510-50/UKCA/UN38.3
13	Environment requirements	RoHS

7.2 APX 14.3P-B1 (Battery Module)

No.	Items	Specifications
1	Model	APX 14.3P-B1
2	Nominal Capacity/Energy	280Ah/14.33kWh
3	Rated/Usable Capacity/Energy	252Ah/12.89kWh
4	Rated Voltage	80V
5	Operating Voltage	0-105V
6	Maximum current (25°C)	140A
7	Peak current (25°C)	196A
8	Battery Type	Cobalt Free Lithium Iron Phosphate (LFP)
9	Operating temperature range	-10~50°C
10	Storage conditions	- 20°C~50°C/7 days; -20°C~40°C/6 months; 5%-95%RH
11	Cooling	Natural cooling
12	Dimensions (W/D/H)	920/510/248mm±2mm
13	Weight	135±1kg

No.	Items	Specifications
14	Installation	floor-mounted installation
15	Warranty	10 Years
16	IP rating	IP66
17	Certification & Licensing	IEC62040/IEC62477/IEC62619/CE/RCM/VDE2510-50/UKCA/UN38.3
18	Environment requirements	RoHS

Formula for calculating the rated capacity of the battery system(EVE):

Rated capacity of a single battery module: 252Ah

N(Number of modules connected in series): 6-14

IFp74/176/209[(16S)NS]M/-10+50/95

Formula for calculating the rated capacity of the battery system(Sunwoda):

Rated capacity of a single battery module: 252Ah

N(Number of modules connected in series): 6-14

IFp73/175/208[(16S)NS]M/0+60/95

Shenzhen Growatt New Energy Co., Ltd.

4-13/F, Building A, Sino-German (Europe) Industrial Park,
Hangcheng Ave, Bao'an District, Shenzhen, China

T +86 755 2747 1942

E service@ginverter.com

W www.ginverter.com



Download
Manual



Growatt New Energy

Shenzhen Growatt New Energy Co., Ltd.

4-13/F, Building A, Sino-German (Europe) Industrial Park,
Hangcheng Ave, Bao'an District, Shenzhen, China

T +86 755 2747 1942

E service@ginverter.com

W www.ginverter.com

GR-UM-349-A-01